

USER MANUAL - v4  
MODOR DIGITAL POLYPHONIC SYNTHESIZER



# Contents

<b>1</b>	<b>Getting Started ...</b>	<b>1</b>
1.1	Warning . . . . .	1
1.2	Connections and settings . . . . .	1
1.3	Menu navigation . . . . .	3
1.4	Loading patches . . . . .	3
1.5	Saving patches . . . . .	4
1.6	Playing monophonic . . . . .	4
1.7	Safety Mode . . . . .	5
1.8	Patch initialisation . . . . .	5
1.9	Autosave . . . . .	6
1.10	Inspect actual parameter values . . . . .	6
<b>2</b>	<b>Overview</b>	<b>7</b>
2.1	Structure of a patch . . . . .	7
2.2	Frontpanel overview . . . . .	8
<b>3</b>	<b>Oscillator section</b>	<b>11</b>
3.1	Using the oscillators . . . . .	11
3.2	Oscillator waveforms . . . . .	13
3.2.1	Sawtooth PWM oscillator . . . . .	13
3.2.2	Square PWM oscillator . . . . .	13
3.2.3	Triangle PWM oscillator . . . . .	13
3.2.4	Sync oscillator . . . . .	14
3.2.5	Additive harmonics oscillator . . . . .	14
3.2.6	Sonar noise oscillator . . . . .	15
3.2.7	Wind noise oscillator . . . . .	15
3.2.8	Arcade noise oscillator . . . . .	16
3.2.9	Sine FM oscillator . . . . .	16
3.2.10	Sine feedback FM oscillator . . . . .	18
3.3	White noise . . . . .	19
3.4	Ring modulator . . . . .	19

---

<b>4</b>	<b>Filter section</b>	<b>20</b>
4.1	LP/HP/BP/BS filter . . . . .	20
4.2	Formant filter . . . . .	22
4.3	Filter configuration . . . . .	24
4.4	Formant filter Midi CC's . . . . .	25
<b>5</b>	<b>Amplifier section</b>	<b>26</b>
<b>6</b>	<b>Effects section</b>	<b>27</b>
6.1	Chorus/Flanger effect unit . . . . .	27
6.2	Delay effect unit . . . . .	29
<b>7</b>	<b>Modulation section</b>	<b>31</b>
7.1	LFOs . . . . .	31
7.2	Sample&Hold . . . . .	32
7.3	Envelopes . . . . .	33
7.4	Modulation Matrix . . . . .	36
7.5	Pitch Modulation . . . . .	37
7.6	Amplitude Modulation . . . . .	39
7.7	Other popular modulations . . . . .	39
<b>8</b>	<b>Tempo synchronisation</b>	<b>41</b>
<b>9</b>	<b>Menu Reference</b>	<b>43</b>
9.1	Load . . . . .	43
9.2	Save . . . . .	44
9.3	Name . . . . .	44
9.4	Init Patch . . . . .	44
9.5	Parameter . . . . .	45
9.6	System Settings . . . . .	46
9.7	Formant Frequencies . . . . .	48
9.8	Tonescale . . . . .	48
9.9	Sysex Dump . . . . .	49
9.10	Menu overview . . . . .	52
<b>10</b>	<b>MIDI Implementation</b>	<b>53</b>
10.1	Midi implementation chart . . . . .	53
10.2	Midi controller list . . . . .	55

## Getting Started . . .

### 1.1 Warning

**Disclaimer** This instrument can produce loud noises that can damage your ears and speakers. Modor Music can never be held responsible for any damage, neither temporary or permanent, to your equipment, your ears, or the ears of other people around you including the audience on public or private shows and/or broadcasts.

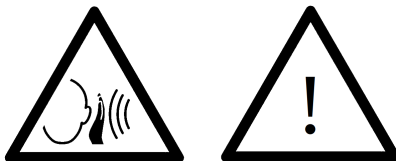

**In practice** Pay special attention to the extreme settings of the feedback parameters in the Chorus/Flanger and Delay effect sections. These can result in sudden loud noise bursts. Get accustomed to the results produced by it while playing on a low volume, before you get surprised by it's effect when playing out loud or during a live gig.

### 1.2 Connections and settings

Before you can start playing the Modor NF-1 a few connections have to be made. This chapter is written to help you make the very first connections and some system settings so that you can immediately start playing your instrument. By following these instructions, you will have your Modor synth up and running in a few minutes time.

**Audio Connections** Connect the Modor NF-1 to an external amplifier or mixing device with an audio cable set via the Left and Right jack connectors on the backside of the instrument. These are two mono 6mm jack sockets. The external amplifier or mixing device should be switched off before making this connection, and only be switched on after the connection has been made to prevent damage to the equipment.

On devices with serial number 170000 or higher, you can also connect headphones to the left audio connector with a 6mm TRS-connector.

Don't mistake the left- and right-audio connectors for the sustain- and volume pedal connectors next to it. These don't output audio signals, but bear a weak electrical tension that might damage your audio equipment in some cases.

**Midi Connection** To play the instrument, it should also be connected to an external keyboard or (computer) sequencer via a midi connection. Connect the midi-out output of this external midi source to the midi-in connector on the backside of the Modor NF-1. On devices with serial number 170000 or higher, there's also a Midi-over-USB connector.

**Power Connection** Finally, the Modor NF-1 has to receive power via the power connector. Connect the adaptor, and turn the volume knob (POW/VOL) on the upper left corner of the front panel clockwise to get the instrument running. Theoretically, any 9V DC-adaptor with 9W power (1000mA) will be sufficient, but there are many DC-adaptors around providing unstable or even plain wrong electrical tensions. Only use the DC-adaptor delivered with the Modor NF-1 or refer to a specialised electronics dealer. Damage to the instrument caused by using a wrong adaptor is excluded from any warranty regulation.

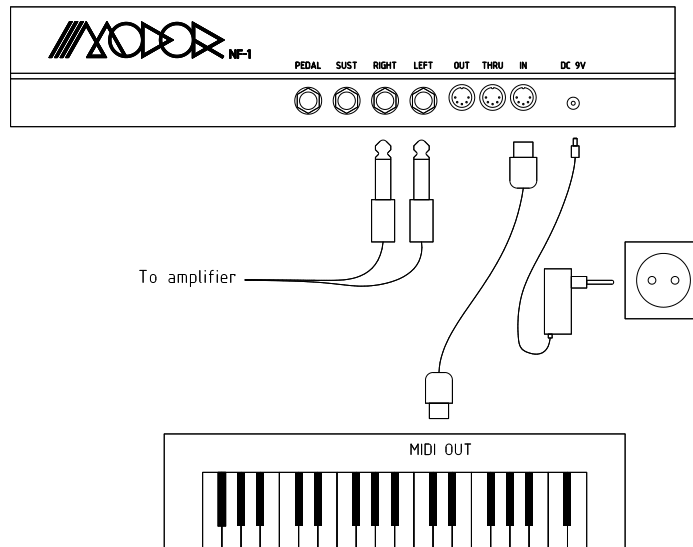

**Setting Midi Channel** Finally the instrument has to be set to the right midi channel such that the channel numbers of the external midi keyboard and the Modor NF-1 match with each other. Look up in the midi source device on which channel the midi data for the Modor is being transmitted, so that we can set the same channel on both devices.

You can find the Midi channel setting in the System Settings menu. Quickly push the MENU button 6 times to access the System Settings menu (see §1.3 below for more info on menu navigation). Next, select the system parameter "Midi Channel" by turning the SELECT data encoder, and set the correct MIDI receive channel with the VALUE control [1-16]. Next press MENU again or press NO/DEST to leave the menu.

```

SYSTEM SETTINGS
Midi Channel:01

```

### 1.3 Menu navigation

The menu of the Modor NF-1 exists out of 9 menu items. When the MENU button is hit you enter the menu, and the first menu item is shown on the upper display line. A black dot starts running from right to left over the display. By pressing MENU again before the dot reaches the left side of the screen, the next menu item is selected. If you stop hitting MENU, after about 1 sec the black dot reaches the left side of the display, and you enter the indicated menu. Following menus can be entered:

1. LOAD: Load a patch from internal memory
2. SAVE: Save a patch into the internal memory
3. NAME: Give your patch a name
4. PATCH INIT: Initialise the patch
5. PARAMETER: To adapt a few sound parameters that have no dedicated knob on the front panel
6. SYSTEM SETTINGS: To set some global system parameters
7. TONESCALE: Change the tuning of a patch with quarter tones up or down
8. FRMFRQ: Set the formant frequencies of the formant filter
9. MIDI DUMP: Dump a single patch or the complete patch memory using Midi Sysex messages

Next, after entering a certain menu, data can be selected and altered using the SELECT encoder and VALUE control. Sometimes you need to validate your choice by pressing the MENU button again, or you might need to approve or cancel your choice by using SRC/YES or DEST/NO. While in the menu, on any moment you can press DEST/NO to cancel and leave the menu. A full item-by-item reference of the complete menu can be found in chapter 9.

### 1.4 Loading patches

Hit the MENU button 1 time and wait 2 seconds to enter the LOAD menu. You should see the following screen: On the first line you see "LOAD?" to indicate you are in the LOAD menu, on the second line you see the active patchbank and -number and patchname (of course, possibly with another patchnumber and patchname as in the example below).

```

LOAD?          Y/N
A00 Init

```

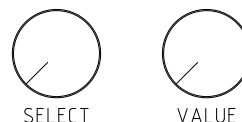

You can now scan through all the available patches in the Modor's memory using the SELECT and VALUE controls. You can also fast forward through the patch banks using the MENU button. Confirm your choice with SRC/YES.

You can push DEST/NO at any time to cancel the load operation and return to the patch you were using before. This way you can listen to the patches in the memory without losing your actual work, and compare your active patch to any patch in the Modor NF-1's memory.

Remark: If the "Load Preview" option in the SYSTEM SETTINGS-menu is OFF, you won't hear the patches in memory until you actually load them.

## 1.5 Saving patches

Saving patches goes identically to loading: now press the MENU button twice within one second to enter the SAVE menu. Select a slot in the memory using the SELECT and VALUE controls. This slot will be overwritten with the actual patch and patchname if you now hit SRC/YES to confirm.

When you play the keyboard during the save operation, you can hear the patch in the Modor NF-1's memory that's about to be overwritten. This way you can check which memory position can be overwritten before actually doing it.

Hitting DEST/NO at any time cancels the save operation and exits the menu of the Modor NF-1.

```

SAVE?      Y/N
A00 Init
  
```

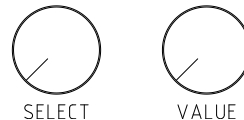

## 1.6 Playing monophonic

A patch can be set to polyphonic, monophonic or mono-legato modes. This setting is saved with the patch and restored when a patch is loaded.

**Polyphonic** You can play up to 8 notes simultaneously. When playing more than 8 notes, the notes that are already in release are dropped first to make room for a new note, than the oldest playing note.

**Monophonic** Only one note can be played, the last played note always has priority. When a note is released, and the previous note is still being pressed, this note is retriggered.

**Mono-Legato** Same as normal monophonic, but now the envelopes continue instead of being retriggered when playing legato notes. Also Portamento only works on legato notes.

Poly/mono/legato modes are set in the PARAMETER-menu. Use the menu button to go to this menu, and use the SELECT-encoder to select the Mono/Poly option. Set the desired playing mode using the VALUE-control.

```

PARAMETER
Mono/Polw  :Polw
  
```



## 1.7 Safety Mode

When loading a preset from the NF-1's memory, the frontpanel control knobs are in a position that doesn't correspond to their actual sound parameters. When you turn a knob on the frontpanel, the sound suddenly changes to the value of the frontpanel knob, and this change can be very abrupt!

No problem as long as you aren't touching these control knobs, or if you are on your own, experimenting with the NF-1 in your home studio. But of course, this can be very annoying in certain cases, for example when playing live. When accidentally touching one of the frontpanel controls, the sound can suddenly change very drastically. That might give the Modor NF-1 a very unreliable or unstable 'feeling' on stage or while jamming in the studio! Imagine what happens when accidentally turning the coarse TUNE control, making the NF-1 suddenly go completely out of tune!

```
SYSTEM SETTINGS
Safety Mode :ON
```

Therefore, a safety mode has been installed in OS004 and following OS versions. When this Safety Mode is activated, the sound parameters do not change when turning a frontpanel knob, until you are passing their actual value. This setting can be found in the SYSTEM SETTINGS menu. Activate the menu by pressing MENU 6x, and use the SELECT-encoder to select this setting. Change it using the VALUE-control.

When Safety Mode is activated and you turn a knob on the frontpanel, a '<' or '>' is displayed when the parameter change is blocked, which indicates at what side you'll find it's actual value. This safety block is released when you turn the knob passing the actual value, and the '<' or '>' disappears. So, if you want a parameter to change, you need to 'go get it' at it's actual setting and turn it up or down to a new value. This way sudden changes of the sound are prevented.

```
AGG Init
FILTER FRO: >032
```

## 1.8 Patch initialisation

How to reinitialise the actual patch? If you want to start building up a new patch completely from scratch, this might be helpful. Quickly hit the MENU button four times to select the PATCH INIT-menu and wait one second to select it (the black dot reaches the left side of the screen). You now get three options when turning the SELECT-encoder:

- Initialise
- Frontpanel
- Autosave

Select one of these, and confirm with SRC/YES (or cancel with DEST/NO).



When you choose Initialise, you get a very clean and simple 'Init' patch consisting of a sawtooth wave on OSC1, the other oscillators have their volumes at zero. The lowpass filter is fully opened and has no resonance, and the amplifier envelope just has a gate-function. No effects are added to the init sound.



When you choose 'Frontpanel', all the parameters are set according to their front-panel control. All non-continuous parameters (such as waveform, filter type, lfo wave, ...) remain unchanged during a Frontpanel Init. Furthermore, only the parameters of the oscillators and envelopes that are active (have burning led inside their selection switch) are set to the frontpanel positions. For example if OSC1 is active and OSC2 and OSC3 are inactive, the parameters MOD, MOD LFO, MOD ENV, TUNE and FINETUNE are only set to their knob positions in OSC1. Those of OSC2 and OSC3 remain unchanged.

## 1.9 Autosave

Sometimes it may happen that you loose your work, due to a sudden power cut, accidentally loading a patch, ... In that case you can reload the Autosave-data in the PATCH INIT-menu. When you don't touch the NF-1 for about 1 minute, all data are automatically saved. This is indicated by a small A↔ in the upper left corner of the screen. If you want to reload the autosave data, get into the PATCH INIT-menu (4x MENU button) and select 'Autosave' with the SELECT encoder. Press SRC/YES to load these data.



## 1.10 Inspect actual parameter values

Sometimes you'll want to know the actual value of a parameter, without changing it. For example to investigate how a certain patch is built or how a certain sound is produced. If you turn a control while keeping the DEST/NO-button pressed down, the value of this control will be shown on the screen. If you turn the control in the OSC- or ENV-section the values for all 3 oscillators / all 4 envelopes are shown.

## 2.1 Structure of a patch

A 'patch' might also be called a 'sound' or an 'instrument'. A patch is defined by a series of parameter settings that determine on how the sound is generated, processed and transformed by the different sections of the synthesizer. When you push a key on the keyboard, a sound is generated by the Oscillator section, filtered by the Filter section, amplified by the Amplifier section and finally somehow altered by the Effects section. That is the general basic structure of many so-called 'subtractive' synthesizers, among which the Modor NF-1. There is also a fifth section, the Modulation section. In this section a number of modulation signals is produced which can be used to alter or 'modulate' the sound creation parameters in the oscillator, filter, amplifier and effect sections. Each of these parts of the synthesizer is further explained in the next chapters.

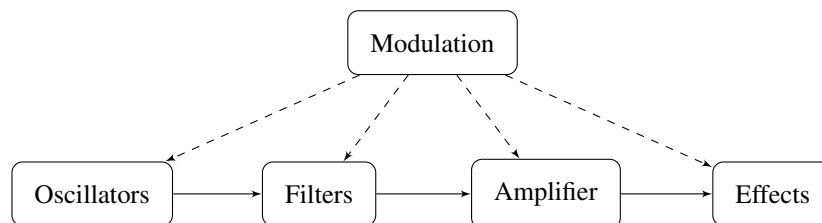

The Modor synth contains:

- Oscillator section, chapter 3
  - 3 oscillators with 10 waveforms
  - a white noise source
  - a ring modulator combining oscillators 2 & 3
- Filter section, chapter 4
  - a classic LP/HP/BP/BS-filter with output drive
  - a formant filter creating voice-like sounds
- Amplifier section, chapter 5
  - an amplifier with volume and pan settings (in PARAMETER menu) and input drive

- Effects section, chapter 6
  - a combfilter effects unit, creating chorus and flanger effects
  - a delay effects unit
- Modulation section, chapter 7
  - 3 low frequency oscillators (LFO's)
  - 4 envelope generators
  - a random sample-and-hold (or noise) modulator and a lowpass-filtered version of this
  - velocity, aftertouch, expression pedal, ... and a number of other modulation signals
  - a modulation matrix with 7 freely assignable modulation "wires" to route any source to any destination

## 2.2 Frontpanel overview

You can find 43 rotary knobs and 20 pushbuttons on the frontpanel of the Modor NF-1, grouped in the sections described above. Each of these sections get further detailing in the next chapters.

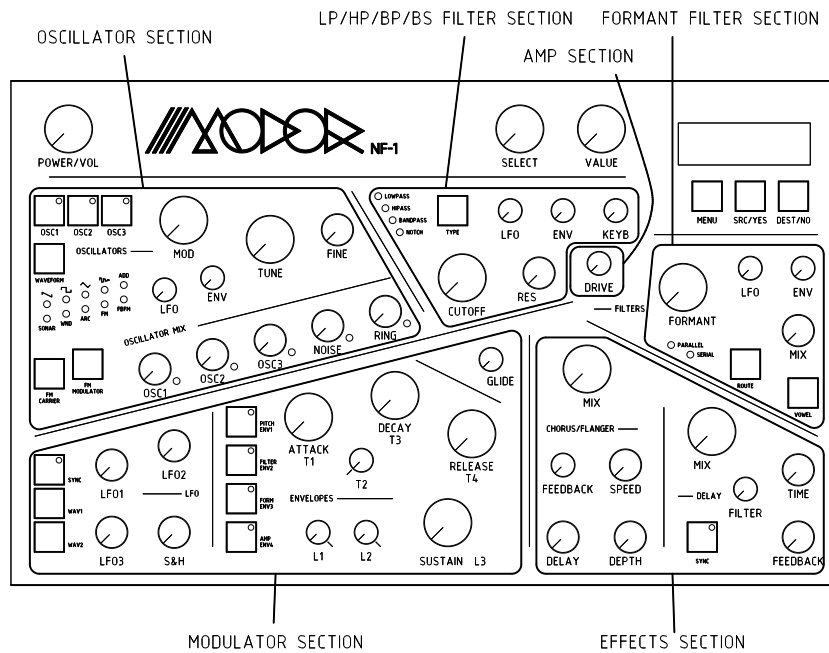

In a short overview, following controls are found:

- Oscillator section, chapter 3
  - OSC1, OSC2 and OSC3 selection buttons to select which oscillator is being edited
  - WAVEFORM selection button, to set the selected oscillator's waveform

- FM CARRIER and FM MODULATOR buttons, to select harmonics of the ADD, FM and FBFM waveforms. These buttons have no function if the selected oscillators have other waveforms than ADD, FM or FBFM.
- MOD control, to modificate the sound of the oscillator [0,127]. The effect is depending on the active waveform. For example, it sets the pulse width for the pulse wave.
- LFO control to set the amount of modulation of the MOD parameter by LFO1 [-64,+63]. If no OSC is selected with the OSC1, OSC2 and OSC3 selection buttons, this control sets the amount of pitch modulation by an LFO source.
- ENV control to set the amount of modulation of the MOD parameter by the envelopes [-64,+63]. This is ENV1 for OSC1 MOD, ENV2 for OSC2 MOD and ENV3 for OSC3 MOD. If no OSC is selected with the OSC1, OSC2 and OSC3 selection buttons, this control sets the amount of pitch modulation by ENV1.
- TUNE and FINE controls to set the pitch of the selected oscillators. TUNE sets the pitch in half tone steps [-32,+31], FINE ranges a half tone up or down [-64,+63].
- OSC1, OSC2 and OSC3 oscillator volume controls to set the volume of each oscillator [0,127].
- NOISE control to set the volume of white noise [0,127].
- RING control to set the volume of an additional ringmodulator acting on oscillators 2&3 [0,127].
- Filter section, chapter 4
  - Switchable LP/HP/BP/BS-filter
    - \* TYPE button to select between hipass, lowpass, bandpass or notch (bandstop) filters.
    - \* CUTOFF control to set the filter's cutoff frequency [0,127].
    - \* LFO, ENV and KEYB controls to set the amount of modulation of the cutoff frequency by LFO2, ENV2 and the keyboard position [-64,+63]. A setting of +32 of the KEYB control makes the filter frequency follow the pitch 1:1.
    - \* RES control to set the "resonance" or "filter quality" of the filter [0,127].
  - FORMANT filter
    - \* ROUTE button to choose between a parallel or serial configuration of the LP/HP/BP/BS-filter and the formant filter
    - \* VOWEL button to select 3 sets of formant frequencies (vowels)
    - \* FORMANT control to morph between the 3 chosen vowels [0,127].
    - \* LFO and ENV controls to set the amount of modulation of the formant morph by LFO2 and ENV3 [-64,+63].
    - \* MIX control to mix the formant filtered signal with other signals [0,127].
- Amplifier section, chapter 5
  - DRIVE control to set the amount of distortion of the signal [0,127].
  - the volume and pan controls are hidden in the parameter menu.
- Effects section, chapter 6
  - Comb filter effect unit, to mix the signal with a slightly delayed version of

itself (up to a few milliseconds). To make chorus, flanger and a number of other effects.

- \* MIX control to mix between the dry signal and the altered signal [0,127].
- \* SPEED control to set the delay modulation speed [0,127]
- \* DELAY control to set the delay modulation range [0,127]
- \* DEPTH control to set the delay modulation depth [0,127]
- \* FEEDBACK control to set the amount of feedback [-64,+63]
- a delay effects unit, to mix the signal with a delayed version of itself (up to 750 milliseconds) to create echo effects.
  - \* MIX control to mix between the dry signal and the delayed signal [0,127]
  - \* TIME control to set the delay time [0,127]
  - \* FEEDBACK control to set the feedback amount [0,127]
  - \* FILTER control to activate a lowpassfilter on the delayed signal [0,127]
  - \* SYNC button to synchronise the delays with a MIDI clock fed to the Modor synth by an external sequencer.

- Modulation section, chapter 7

- GLIDE control to set the portamento time
- The envelope subsection, containing 4 3-stage envelopes. By setting T2=0 and L1=L2=127 this turns into a classic ADSR-envelope.
  - \* ENV1, ENV2, ENV3 and ENV4 selection buttons to select the envelopes to edit.
  - \* T1, T2, T3 and T4 time controls [0,127].
  - \* L1, L2 and L3 level controls [0,127].
- The LFO subsection, containing 3 LFO's and a random sample-and-hold modulator. LFO3's amplitude is set by the modwheel.
  - \* SYNC button to synchronise LFO2 with a MIDI clock fed to the Modor synth by an external sequencer.
  - \* WAV1 and WAV2 buttons to set the waveforms of LFO1&2.
  - \* LFO1, LFO2 and LFO3 speed controls [0,127].
  - \* S&H random sample-and-hold speed control [0,127].

- Menu, chapter 9

- MENU button to enter the menu and select a submenu.
- SRC/YES button to set the modulation wire sources (§7.4) or to choose "Yes" in certain menu's.
- DEST/NO button to set the modulation wire destinations (§7.4), to cancel or to choose "No" in certain menu's.
- SELECT encoder and VALUE control to set the menu parameters, select a patch to load, ...

## Oscillator section

### 3.1 Using the oscillators

The oscillators are the sources of the sound in a synth. There are three identical fully independent oscillators in the Modor synth, oscillators 1, 2 & 3. Every oscillator has a "modification" parameter (MOD), a pitch (TUNE and FINE) and 2 modulation controls to set an amount of low frequency oscillator and/or an envelope modulation (LFO and ENV). Further every oscillator has it's harmonics settings for the ADD, FM and FBFM waveforms. Every oscillator has its own FM CARRIER and FM MODULATOR.

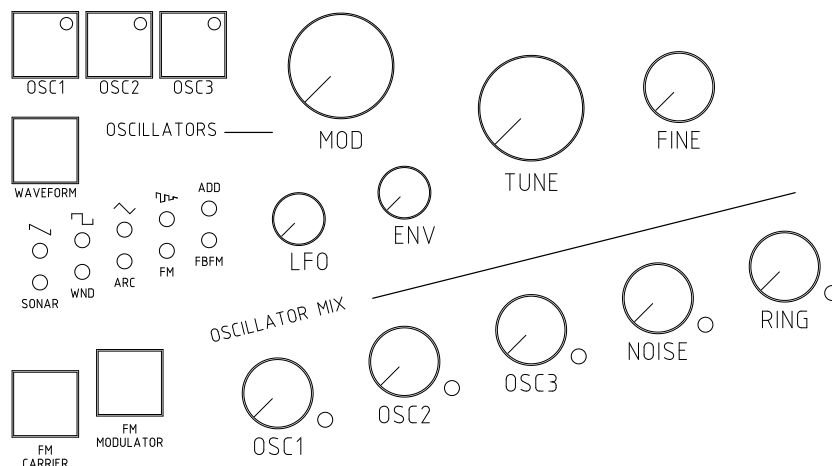





**Selecting an oscillator:** In the oscillator section on the frontpanel we find six push-buttons and ten rotary knobs. Three of the push-buttons are used to select which oscillator is being edited (OSC1, OSC2 and OSC3). The accompanying leds show which oscillators (1,2 and/or 3) are selected, several oscillators can be selected at the same time. If now any setting in the oscillator section is changed by turning a rotary button are pushing waveform, this parameter is changed identically for all the selected oscillators. If for example, oscillators 1 and 3 are selected, and the 'coarse pitch' knob is set to +12, oscillator 1 and 3 are pitched up 12 semitones, while oscillator 2 stays at it's original pitch.

You can select multiple oscillators simultaneously by pushing their selection buttons together.

Remark that these selection pushbuttons are not enabling or disabling the oscillators! This might be a little confusing when using the NF-1 for the first time. To enable or disable an oscillator, just set its volume with the OSCILLATOR MIX controls.

**Pitch modulation:** When none of the three oscillators is selected (the leds in the OSC1, OSC2 and OSC3 buttons are off) the LFO and ENV controls double up as pitch modulation controls. By turning these controls an amount of LFO and ENV modulation of the pitch is possible. ENV1 is the pitch envelope, the LFO source can be chosen in the PARAMETER-menu (§9) between LS&H, S&H, LFO2 and LFO1.

**Selecting a waveform:** The first choice to make is the waveform of an oscillator. There are 10 possible waveforms, treated in the following paragraphs. Every waveform has a MOD (modify) parameter changing the oscillator's output in a certain way, for example the pulsewidth modulation on the Square PWM wave or the modulation depth for FM waveforms.

	Sawtooth PWM	Pulse width modulation
	Square PWM	Pulse width modulation
	Triangle PWM	Pulse width modulation
	Sync OSC	Pitch of osc synced to base freq
ADD	Additive harmonics	Harmonic separation
SONAR	Sonar noise	Filter Resonance
WND	Wind noise	Hipass filter
ARC	Arcade noise	Hipass filter
FM	Sinus FM	FM amount
FBFM	Sinus Feedback FM	FM amount

This MOD-parameter can be modulated by LFO1 and/or an Envelope (ENV1, ENV2 and ENV3) using the rotary buttons MOD LFO and MOD ENV.

LFO1	→	MOD OSC1, OSC2 en OSC3
ENV1	→	MOD OSC1
ENV2	→	MOD OSC2
ENV3	→	MOD OSC3

The pitch of every oscillator can be adjusted independently using TUNE for semi-tone steps, and FINE for finer subdivisions in the semitones.

**Oscillator mix** Each of the three oscillators, the white noise source and the ring modulator have their own level control in the OSCILLATOR MIX. By turning the volume up, you enable a sound source. The accompanying led will be lit if the volume is set to a value bigger than zero.



## 3.2 Oscillator waveforms

### 3.2.1 Sawtooth PWM oscillator

The sawtooth oscillator generates a sawtooth wave with a pulse width modulation as in the figure below. With the modification parameter MOD at zero this gives a regular sawtooth waveform, turning up MOD creates "holes" in the sawtooth that sound a bit like the classic PWM on a square waveform.

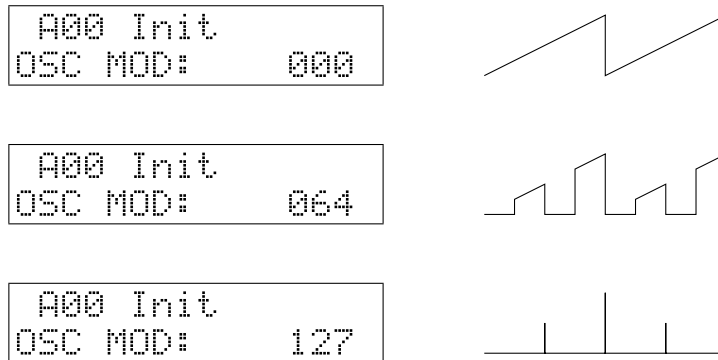

### 3.2.2 Square PWM oscillator

The square oscillator generates a classic "square" or "pulse" waveform in which the MOD parameter determines the duty cycle of the pulse. The sound of this waveform gets more and more "thin" with increasing MOD-parameter.

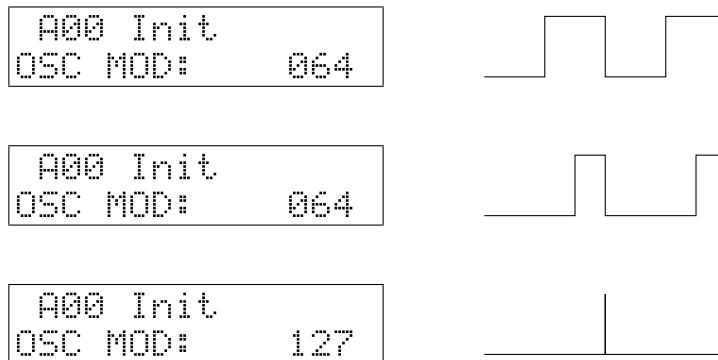

### 3.2.3 Triangle PWM oscillator

The triangle oscillator creates a classic triangle waveform, from whom the width of the two halves of the waveform can be changed, as in the figure below. With higher MOD setting, more and more overtones are added to the sound of the triangle wave.



```
A00 Init
OSC MOD: 064
```



```
A00 Init
OSC MOD: 127
```

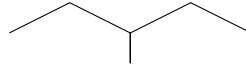

### 3.2.4 Sync oscillator

This oscillator creates a synced square wave with a decaying amplitude as shown in the figures below. This sounds very much like a synced waveform found on many other subtractive (virtual) analog synthesizers.

```
A00 Init
OSC MOD: 000
```

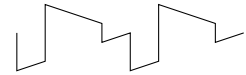

```
A00 Init
OSC MOD: 032
```



```
A00 Init
OSC MOD: 127
```



### 3.2.5 Additive harmonics oscillator

The additive harmonics waveform creates harmonic sine waves with frequencies in multiples of the base frequency  $f$ . The modification parameter (MOD) determines the distance  $N$  between consecutive sinewaves in multiples of  $f$ ,  $N$  can be varied from 1 to 16.

**N=1** :  $f, 2f, 3f, 4f, \dots$  (sawtooth)

**N=2** :  $f, 3f, 5f, 7f, \dots$  (square wave)

**N=3** :  $f, 4f, 7f, 10f, \dots$

**N=4** :  $f, 5f, 9f, 13f, \dots$

and so on ...

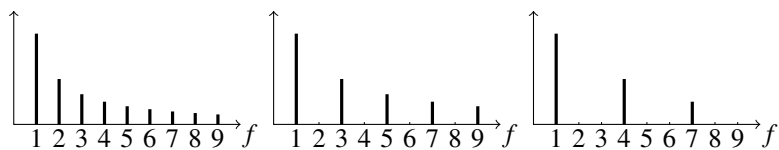

For  $N=1$ , we have a sound carrying all the harmonic overtones of  $f$ , which creates a sawtooth wave, and for  $N=2$  we have only the odd harmonics, which creates a square wave. The only difference is that the number of harmonics that can be created in real-time is limited. On the lower part of the keyboard we hear that the "additive sawtooth" sounds more dull than the "real sawtooth" of the SAW PWM oscillator.

The additive harmonics oscillator still has another parameter: The FM-carrier parameter can be used to make the harmonic series start with another harmonic than  $f$ . Use the FM CARRIER button and the SELECT encoder to set another start harmonic. For example:

**S=2 en N=3** :  $2f, 5f, 8f, 11f, \dots$

**S=3 en N=1** :  $3f, 4f, 5f, 6f, \dots$  (a sawtooth with missing lower 2 harmonics)

**S=3 en N=2** :  $3f, 5f, 7f, 9f, \dots$



### 3.2.6 Sonar noise oscillator

This oscillator creates white noise filtered by a resonant bandpass-filter. The modification parameter controls the resonance of this filter. With MOD at zero, you get bandpass filtered noise, the filter frequency depending on the played note's pitch. With increasing MOD, the sound gets more and more tonal, filtering out more and more noise frequencies around the central peak frequency while enhancing frequencies close to the peak. At maximum resonance this goes up to an almost pure sine wave of self-oscillation. A sound that resembles that of a U-boat sonar.

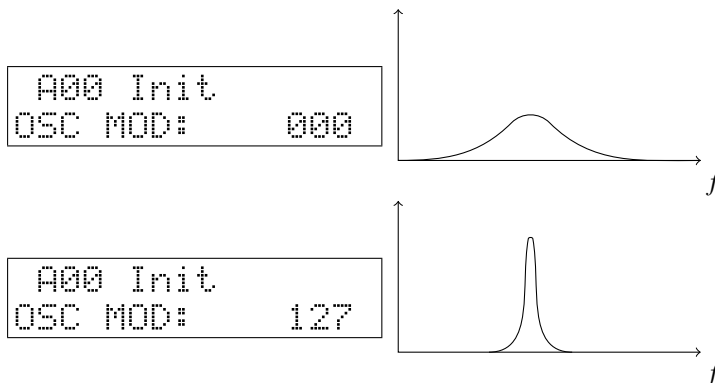

### 3.2.7 Wind noise oscillator

The Wind noise oscillator creates a tonal noise. A source of white noise is being filtered to pronounce the note's main frequency and its harmonics, creating a sound with noisy harmonics, sounding not unlike a blow on a bottle or a panflute.

The modification parameter controls a 1-pole hipass filter. With MOD at zero, all the noisy peak harmonics come through, increasing MOD gradually diminishes the sometimes disturbing lower parts of this.

The wind noise oscillator sounds particularly well on higher notes, where it can give the sounds of other oscillators a special bright character in a mix.

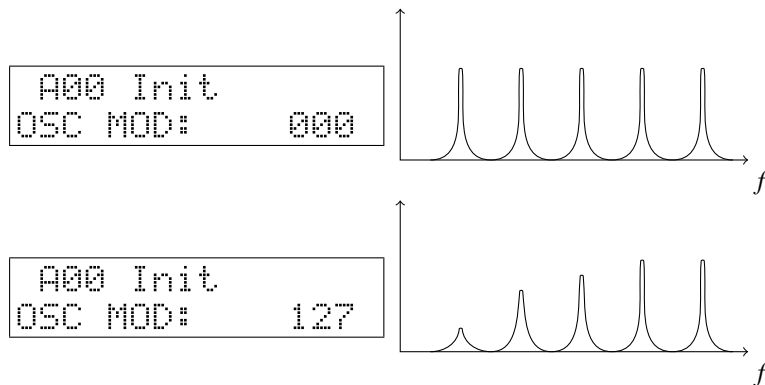

### 3.2.8 Arcade noise oscillator

This oscillator creates a type of hard noise with a certain tonal character. This type of noise is remodelled after the noise creation algorithms present in early arcade video game machines. It creates waves that look like pulses with randomly varying pulse length.

In the age of early arcade video games the computer processors didn't have the capacity to create digital sounds themselves. Instead, computer game consoles had dedicated sound/music chips under the hood, able of creating simple basic waveforms to play melodies, and a rude noise generator for sound effects and "percussion". Some of these chips had the ability to create this typical arcade noise, which had a "frequency" to simulate some kind of "filtered noise".

It might sound a bit unusual and unusable on its own in a synthesizer, but this waveform can be used together with other oscillators to produce a noisy, tearing kind of sound. The MOD-parameter controls a 1-pole hipass filter like on the wind noise oscillator, eliminating the sometimes annoying lower noise frequencies.



### 3.2.9 Sine FM oscillator

The sine FM oscillator creates a sine waveform called "the carrier", whose frequency is being modulated by another sine waveform, "the modulator". You don't hear the modulator itself, but you hear its effect upon the carrier. The MOD-parameter in this oscillator is the amount of this frequency modulation. With MOD set to zero (and no modulation of MOD) you will hear a pure sine wave. When turning up the MOD-control, you hear the sound changing, becoming more and more "rich" with increasing MOD. More and more harmonic overtones are added to the basic sine wave.

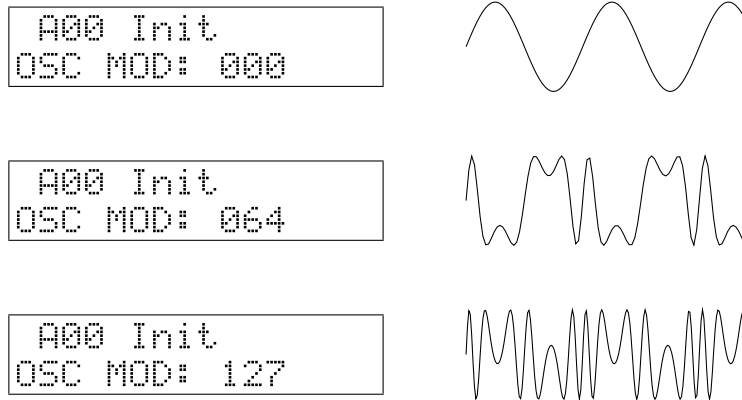

The modulator's frequency is in the audio range, just as the carrier frequency. You won't hear a sine wave going up and down in pitch, as you might expect when hearing the term "Frequency Modulation", as if its frequency is modulated by an LFO. The modulation process goes that fast that it changes the "character" of the sound, not its pitch. This is caused by the fact that also the modulator has an audio-scale frequency. Upon initialisation of a patch, the frequency of the FM-oscillator's modulator is equal to the frequency of the carrier. It is said they have a frequency ratio of 1:1.

This ratio can be changed using the FM CARRIER and FM MODULATOR buttons. Both carrier and modulator can have their frequency changed to a multiple of the base frequency. This makes it possible to work with frequency ratios of for example 2:1, 3:1, 3:2, 9:7, 8:5, ... . Each one of them resulting in a different timbre. Push the FM CARRIER button to change the carrier's harmonic, push the FM MODULATOR button a second time for the same action on the modulator. You can try out any setting with the carrier up to 8x and the modulator upto 16x the base frequency.

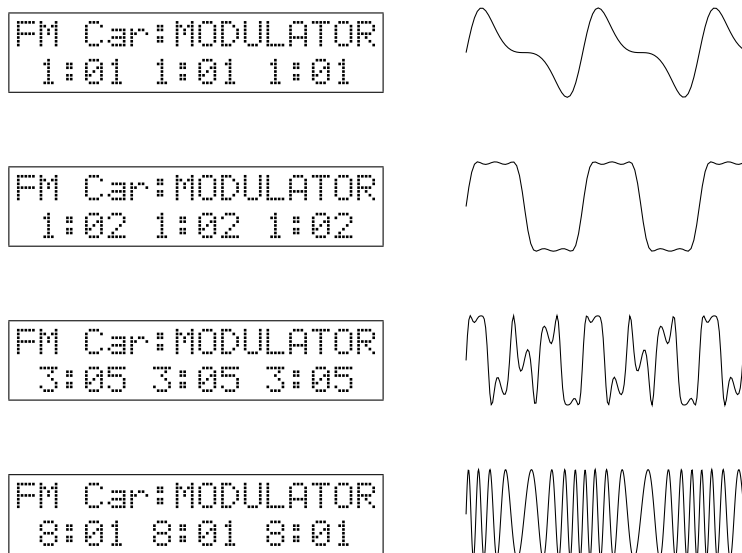

This kind of FM-synthesis is similar to the Yamaha FM-synthesizers of the 80's era. The use of sine waveforms keeps the amount of harmonics relatively low and

under control as opposed to modulating a sawtooth's frequency with another sawtooth. As such, it is somewhat different in character from the FM or "cross-modulation" often found on analog(-modelling) synths where one overtone-rich oscillator modulates the frequency of another, creating even more overtones.

The carrier and modulator are generated independently of what happens in other oscillators. This way, it gives the unique possibility of combining for example a glassy 80's style-FM oscillator with classic analog or other waveforms. You don't have to use one oscillator to frequency-modulate another.

Some very typical 80's FM-style patches can be made using an envelope to modulate the fm amount (MOD ENV). After initialising a patch, set the waveform to FM. Choose a frequency ratio with FM MODULATOR, and set a certain (positive) amount of envelope modulation on it using the ENV control of the oscillator. This gives you a sound with a bright attack as found in vintage electric piano's and toy instruments, especially with a higher modulator frequency.

### 3.2.10 Sine feedback FM oscillator

The sine feedback FM oscillator does something very similar to sine FM. But in this oscillator the modulator first modulates itself, before modulating the carrier. This results in timbres with a lot more harmonics than with simple sine FM, sounding a lot brighter than a sine FM oscillator having the same settings. For example: at a frequency ratio 1:1 and MOD set around +32, a sawtooth appears. Playing with the MOD-parameter, the character can be varied to other "sawtoothish" sounds. The same thing happens with ratio 2:1 where a square wave appears.

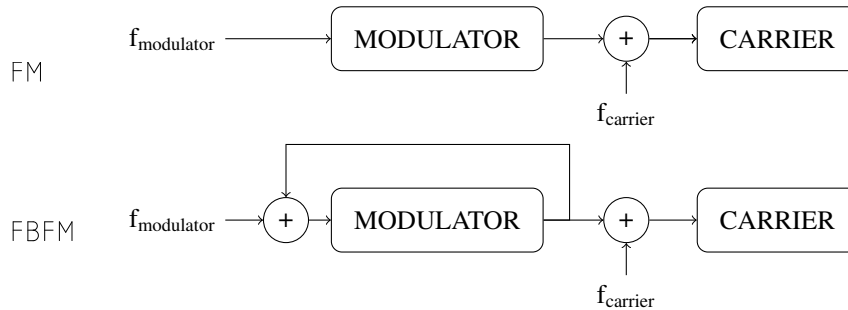

```

FM Car:MODULATOR
1:01 1:01 1:01
-----
A00 Init
OSC MOD: 032

```

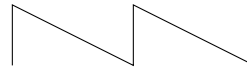

```

FM Car:MODULATOR
1:02 1:02 1:02
-----
A00 Init
OSC MOD: 032

```



### 3.3 White noise

In the oscillator mix section on the front panel, an amount of white noise can be added to the oscillator mix. White noise is a form of noise that has an equal amplitude on all frequencies, it is completely atonal.

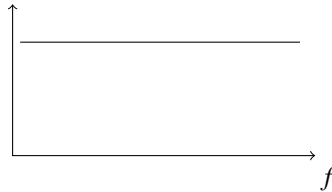

### 3.4 Ring modulator

The ring modulator creates a multiplication of the signals from oscillator 2 and 3, which results in a mix of sums and differences of the frequencies present in the source oscillators. This mix of sums and differences gets most interesting when OSC2 and OSC3 have a different tuning, which might induce inharmonic frequency peaks in the sound.

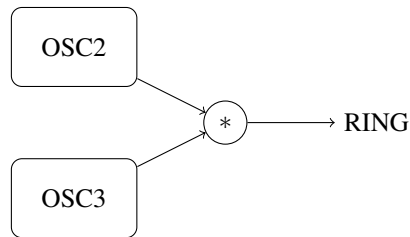

## Filter section

### 4.1 LP/HP/BP/BS filter

The main filter of the modorsynth is a multimode LP/HP/BP/BS resonant filter. You can select it to be a lowpass (LP), highpass (HP), bandpass (BP) or bandstop (BS) filter. A filter eliminates a certain part of the sound and lets another part pass. In a lowpass filter for example, the sound frequencies above a certain cutoff frequency are blocked, while the frequencies below this cutoff frequency pass through the filter.

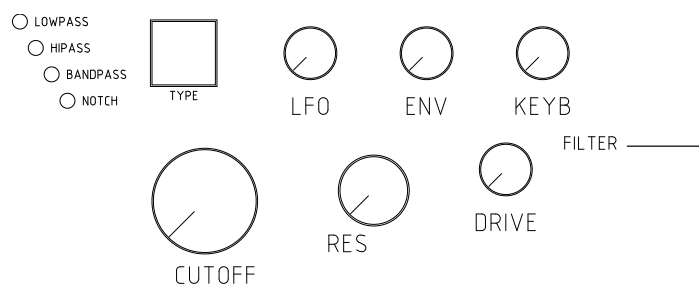

*Resonant* means that it is possible, by turning up the RES control (filter Resonance) to enhance the frequencies close to the cutoff point. This results in a certain sound character, quite typical to synthesizer sounds. With increasing resonance, these frequencies are amplified more and more, up to selfoscillation, where the original sound is oppressed by a cutoff frequency wave generated by the filter itself.

**LP** The lowpass filter blocks the higher frequencies and lets the lower frequencies pass. This is the most popular, widely used filter in synthesizers. Especially in combination with a filter envelope (turn up the ENV-knob) and a high RES setting very typical synthesizer sweeps are made. A faster envelope can alter a sound by giving it a short, bright attack and a darker body.



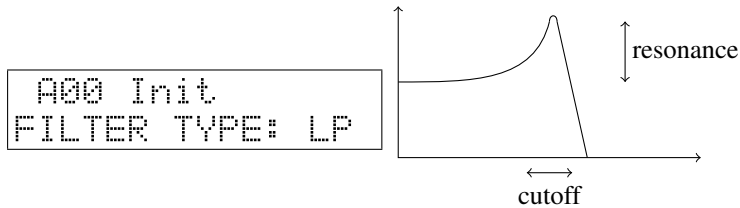

With the RES control at maximum [127] the filter goes into selfoscillation. This means that a bright, sinusoidal wave is generated by the filter itself. Even without input, with all oscillator volumes set to zero, the filter keeps producing sound. With the KEYB control set at +32, you can even "play the filter". To do this however, it can be necessary to feed a very little bit of sound or noise into the filter (ex. NOISE control at very low level) to "excitate" the filter.

**HP** The highpass filter reverses this behaviour, it passes the higher frequencies and blocks the lower, resulting in bright sounds, or upto very thin sounds for high cutoff settings. The resonance parameter again enhances the frequencies around the cutoff frequency, upto selfoscillation.

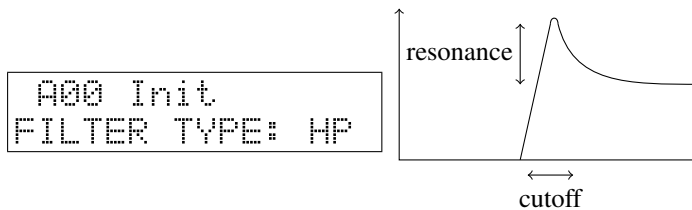

**BP** The bandpass filter only passes a certain amount of frequencies around the center, cutting away the higher and the lower frequencies. Higher Q results in a smaller but higher frequency peak, upto self oscillation.

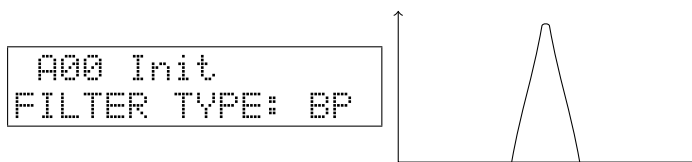

**BS** The bandstop or notch filter is the reverse of the BP, it passes all frequencies, except for a certain range around the central frequency. sweeping the cutoff-frequency of the BS-filter results in a somewhat phaser-like sound. With increasing RES, this stopband becomes smaller and smaller, until the effect of the filter is almost unhearable. If the BS-filter seems to have no effect, decrease the resonance control.

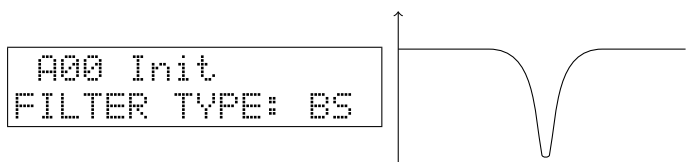

Three standard modulation sources are hardwired to the filter's cutoff frequency. You can modulate the filter by a low frequency oscillator (LFO), an envelope (ENV) and/or by the note's base frequency (KEYB) using the three rotary knobs LFO/ENV/KEYB of the filter section. The LFO that is wired to this knob is the global LFO2, of which the speed and waveform can be set in the LFO section. The envelope wired to the filter is ENV2. Modulating with the KEYB-knob means that the cutoff frequency will go higher with increasing pitch, and lower with decreasing pitch, or reverse for a negative modulation amount. At a setting of +32 the cutoff frequencies exactly follows the note frequency, necessary to keep the sound character unchanged with the pitch over the whole keyboard.

```

A00 Init
FILTER KEYB: +32

```

Other modulations of the cutoff frequency or resonance, for example by velocity or modwheel, is possible using the 7 freely assignable modulation lines (§7)

## 4.2 Formant filter

The formant filter is a very unique filter, never seen in any synthesizer hardware before. It enhances so-called "formants" or peak frequencies in the sound into specific combinations that make the filter sound like the vowels of the human voice. The formant filter has 3 user-selectable vowels (or 3 sets of formants) behind the full-left, 12 o'clock and full-right positions of the FORMANT control. After patch initialisation these vowels are set at A (left) - E (center) - O (right). Turning the FORMANT control morphs the sound between these three vowels.

The MIX parameter of the formant filter section mixes between a signal with and without formant filtering. Turn it right to hear the effect of the formant filter. See also §4.3

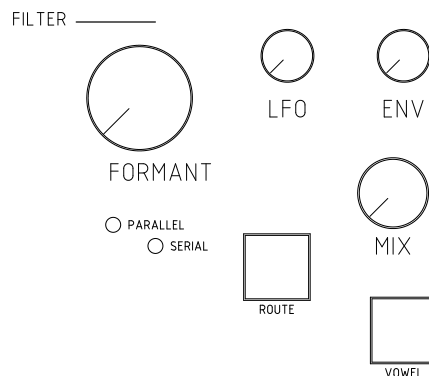

**Formant frequencies** The human brain recognises vowels as specific combinations of peak frequencies. Depending on the movements one makes with it's mouth and throat, certain frequencies of the sound made by the vocal cords are emphasized, while others are suppressed. For example, if a sound has peaks around 800Hz, 1200Hz and

2800Hz, it sounds like a 'A'. Ten presets of these peak frequency combinations are programmed inside the Modor NF-1 and can be selected and placed in the three vowel slots at left, center and right positions of the FORMANT-control.

Vowel	Formant 1 [Hz]	Formant 2 [Hz]	Formant 3 [Hz]	Format 4 [Hz]
A	808	1132	2848	3852
E	345	1195	2725	3852
O	412	808	2725	4845
I	264	2153	2973	3298
OE	194	945	2431	3298
EI	808	2100	2848	3852
EU	389	1132	1995	4373
AO	566	808	2431	4685
U	227	1602	1995	3500
UI	622	1293	2207	3780

Push the VOWEL button to choose one of the three formant slots (1-2-3), and turn the SELECT encoder to pick a vowel (A-E-O-I-OE-EI-EU-AO-U-UI). Any combination of 3 vowels can be made.

```

A00 Init
VOWEL 1 : EI

```



Apart from these presets, you can also alter these formant frequencies by yourself in the FRMFRQ-menu to any combination of formants you want. This is explained further in the menu reference, §9.

**Formant mix** After patch initialisation, the effect of the formant filter isn't heard, the filter seems inactive. This is because the formant mix is set to zero. The formant mix parameter has to be set at a non-zero value, by turning the MIX control of the formant filter to hear the effect of the filter. What the MIX control exactly does depends on the filter configuration (§4.3), but it always mixes the output of the formant filter with a sound without formants. As such you can choose how "present" the formants are in your sounds by turning the mix-knob, from a slightly vowelish character to a real singing voice.

**Formant filter input** To clearly hear the effect of the formant filter, the input signal needs to contain a broad range of frequencies. This way the formant peaks get clearly audible. That means that the input signal needs to have many overtones, it works very well with sawtooth-waves, much less on a triangle wave, and is barely noticeable on a sine wave. This also means that the input signal needs to carry sufficient low frequency components. In the upper octaves of the keyboard, the vowels get less pronounced, while overtone-rich waveforms like a sawtooth or square wave in the lower octaves make the formant filter very present.

### 4.3 Filter configuration

The filter configuration can be set to serial or parallel, using the ROUTE button in the formant section. The corresponding leds on the frontpanel indicate which is the actual configuration.

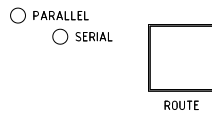

**Serial** In the serial configuration the sound of the oscillators is first led into the formant filter and then into the LP/HP/BP/BS-filter. The mix-parameter of the formant filter forms a dry/wet-mix between the formant filter output and a dry, unfiltered signal. The result of this mix is then filtered by the LP/HP/BP/BS. In this configuration it is for example possible to make a mix of a dry signal and a formant filtered signal, and lead the result into a bandpassfilter to limit its frequency range. This way the output of the formant filter can be further adapted using the LP/HP/BP/BS-filter.

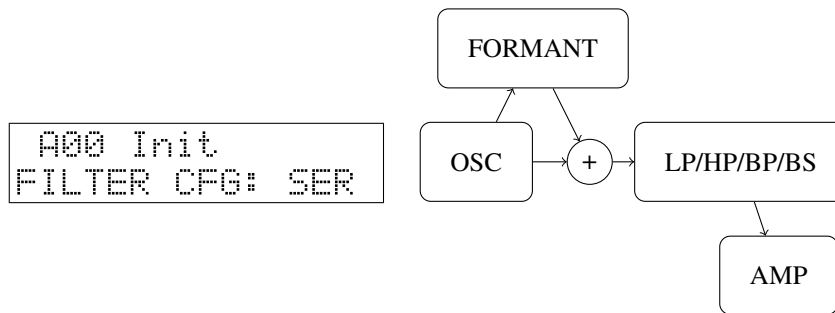

**Parallel** In the parallel configuration, the dry output of the oscillators is led to both the formant filter and LP/HP/BP/BS-filter in parallel. The two output signals of the two filters are then mixed together by the MIX-parameter. It is not possible to adapt the output of the formant filter with a LP/HP/BP/BS-filter, the two filters are separated. In this configuration it is for example possible to work with a formant-filtered sound, and to add an amount of high frequencies by adding some hipass-filtered "original" signal. This way you can brighten up the formant filtered signal which can sound somewhat dull due to the lack of higher harmonics in the filter result.

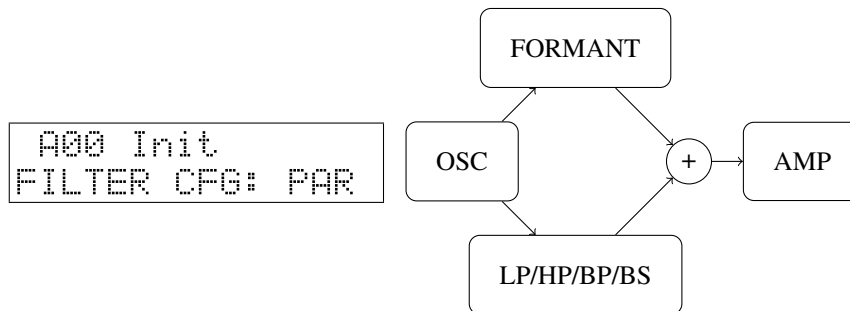

## 4.4 Formant filter Midi CC's

You can also control the formant frequencies using Midi CC messages, see the table below for CC values of the preset vowels.

	Midi CC#	A	E	O	I	OE	EI	EU	AO	U	UI
Formant 1	106-110-114	49	32	35	28	24	49	34	41	26	43
Formant 2	107-111-115	58	77	49	80	53	79	58	49	77	62
Formant 3	108-112-116	92	90	90	94	85	92	77	85	69	81
Formant 4	109-113-117	107	107	120	99	99	107	114	118	102	106
Formant Vol	41-42-43	52	125	32	127	11	103	39	25	35	43

## Amplifier section

The amplifier section is quite straight-forward. First the output of the filter section can be overdriven using the DRIVE-control, next it sets the volume and panning of the sound, using the Amp envelope (ENV4) and the VOLUME and PAN settings in the PARAMETER menu. It finally mixes all the different polyphonic notes together and sends the result into the effects section. So, after the amplifier section, the sound of a single note can not be altered any more. The effects sections treats the polyphonic mix of all the separate notes in bulk.

**Drive** The output of the filter section is sent into a rather soft sounding overdrive unit. A higher setting of DRIVE adds some extra overtone harmonics to the sound. This can for example sound well with higher RES-settings by creating overtones of the RES peak frequency.

**Amplifier envelope** The amplifier envelope ENV4 is always hard-wired to the VOLUME parameter and sets the volume evolution over time. The volume can also be modulated using one of the 7 freely assignable modulation wires (see §7), for example by an LFO to create a tremolo effect. The panning parameter determines the position of a note in the stereo left-right image. It can be set in the PARAMETER-menu and can also be modulated using any modulation source.

**Level and Pan parameters** To access the PARAMETER menu, push the MENU button 5x shortly after each other. You can select a parameter by turning the SELECT encoder, and change it using the VALUE-control.

```
PARAMETER
Level      : 097
```

```
PARAMETER
Pan       : +00
```

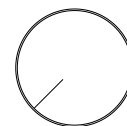
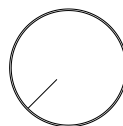

SELECT

VALUE

## 6.1 Chorus/Flanger effect unit

Chorus, phaser and flanger effects are created by a so-called 'modulated comb filter'. A comb filter takes a signal and adds a slightly delayed version of the same signal to it, eventually with a feedback loop to repeat the delay multiple times. The delay time stays in the order of maximally a few hundredths of a second. The delay time can be modulated by a triangle LFO. The Modor NF-1 contains a comb filter effect unit in which all the parameters can be set separately by a dedicated control, to offer maximal freedom.

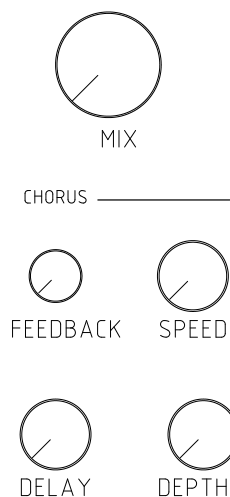

The comb filter is called that way because it creates a series of equally spaced peaks and holes in the frequency spectrum of a signal, like the teeth of a comb. The space between adjacent peaks is determined by the delay length, the depth of the peaks and holes can be set with the feedback parameter, more feedback gives a more pronounced comb filter effect.

The parameters of the comb filter are:

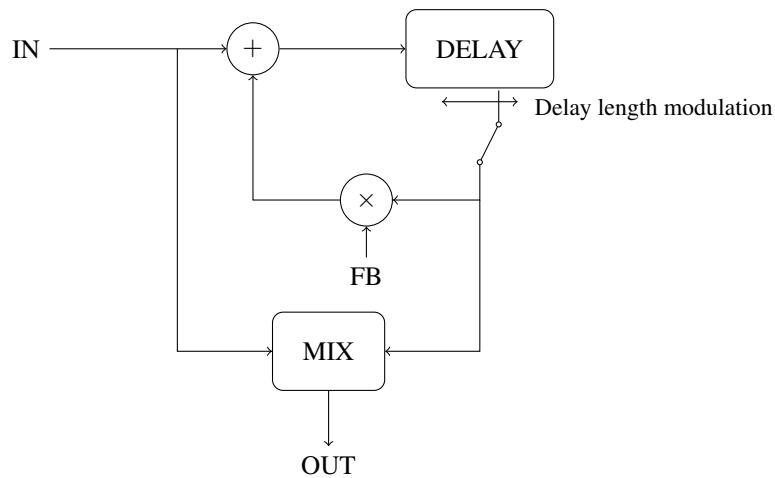

**Dry-wet mix** This control sets the balance between the dry signal and the delayed signal. This is set to zero to disable the comb filter effect unit, and often around halfway to get a maximum chorus or flanger effect.

**Delay length** The delay length control sets the center around which the delay length is modulated.

**Delay length modulation depth** The delay length gets continuously varied around the central delay length by a separate triangle LFO. This control sets the modulation depth, from zero (no modulation) upto maximum where the length is modulated between zero and 2x center length.

**Delay length modulation speed** This control sets the speed of the effect's triangle LFO.

**Feedback** With the feedback control, an amount of the comb filter's delay is fed back into the input, to enhance the filtering effect. This goes from a central zero (no feedback) to a full negative or positive feedback where some very unmusical effect can be created.

**Warning:** Extreme values of the feedback parameter can cause loud noise bursts, which can damage your equipment or ears. Get accustomed to it before using it on high volumes.

There are no effect presets, and every parameter can be set freely and independantly to any value. So you might need some exercise to learn how to create a certain effect. Following typical effects can be made using the combfilter unit:

- **Vibrato:** Fully turn the MIX-control right, such that only the delayed signal is heard, and set the feedback to zero (center). Now play with the delay length parameters to find a good vibrato.



- *Chorus*: A chorus effect tries to emulate multiple, slightly detuned voices, like in a choir or ensemble. This is done by adding a delayed signal to the original signal that is played alternately a little faster and a little slower than the original, resulting in it's pitch going up and down. To achieve a chorus effect, set the dry-wet mix around half way, creating a mix of the original with the delayed signal. No or only very little feedback is added. Set the DELAY-control rather high, and experiment with the SPEED- and DEPTH-control to receive a well-sounding chorus
- *Flanger*: A typical flanger effect can be get with a quite high amount of positive feedback and a very short delay line. Set the DELAY-control close to but not equal to zero, turn up the FEEDBACK-control close to maximum and set the MIX somewhere halfway. Now play with the SPEED- and DEPTH-controls to get the flanger effect you want.
- *Pure comb filtering*: When the modulation depth is set to zero the delay length is not modulated. Set dry/wet around halfway to get a pure, static comb filtered output.
- *Feedback*: With the modulation depth at zero, and the feedback fully positive or negative, you get a heavy feedback signal almost like on an heavily distorted feedbacking electrical guitar. Set the MIX-control somewhere halfway, and DEPTH at zero. Turn the FEEDBACK-control fully up (positive feedback) or down (negative feedback). The delay length control sets the feedback frequency.

Every parameter of the chorus/flanger effect unit can also be modulated using one of the 7 free modulation 'wires' (see §7.4), which creates possibilities for very special effects. You can for example modulate a feedback frequency with an envelope, randomize your flanger speed or set the dry-wet mix with a foot pedal, or ...

## 6.2 Delay effect unit

The delay effect unit creates echos in the sound, by adding a delayed version of itself to the input signal. That is indeed quite identical to the comb filter effect unit, but the delay lengths are much longer, such that separate echo's can be heard instead of a combfiltered signal. The delay lengths go up to around 750 milliseconds.

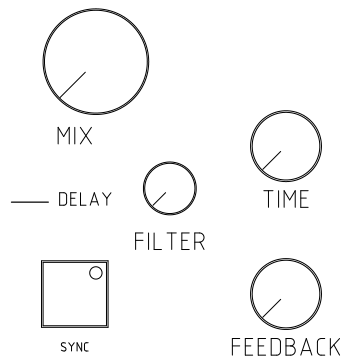

The Modor NF-1's delay effect unit has a 1-pole lowpass filter in the delay line. By setting it at maximum, the filter is inactive. Lowering this value applies a filtering to the signal that gets more and more dull with each repeating echo. This sounds a bit like older analog delay units.

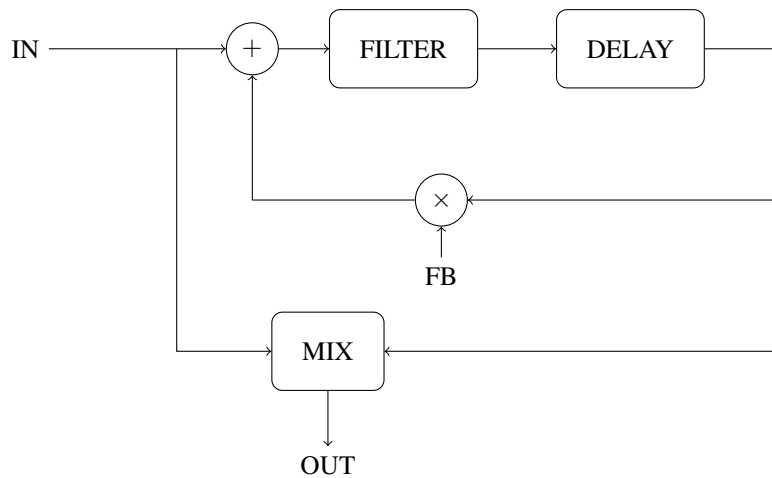

The parameters of the delay effect unit are:

**Dry-wet mix** The MIX control sets the balance between the dry signal and the delayed signal. This is set to zero to disable the delay effect unit.

**Time** This control sets the delay length. When TIME is turned while the SYNC button is pressed, it sets the internal clock BPM.

**Filter** This control acts as a filter on the delay line. With the FILTER control at maximum, the filter is fully open and no effect is heard.

**Feedback** The feedback sets the amount of delay output that is fed back into the delay line. A feedback setting of zero blocks the feedback line, such that only a single echo is heard. Setting it at maximum, the feedback gets high enough for the echo's to keep getting louder and louder.

⚠ Mind your speakers and your ears when using high feedback settings!

**Sync Button** By pressing the Sync button, the delay synchronises:

- Externally to the midi clock signals sent into the Modor synth by an external sequencer. The time control can now be used to set the delay length from half notes to sixteenth notes.
- Internally to the internal clock of the NF-1. Turn the TIME control while pressing the SYNC button to set the internal clock BPM.

Double-click the SYNC button to switch between internal and external syncing. Mostly, for the delay effect unit, it is best to use internal syncing. External syncing might be slightly unstable resulting in pitch deformations of the delay signal.

Every parameter of the delay effect unit can also be modulated using one of the 7 free modulation 'wires' (see §7.4).

## Modulation section

### 7.1 LFOs

An LFO, or "Low Frequency Oscillator" produces a cyclic modulation signal that can be used to modulate a number of sound parameters. The frequency of the Modor LFO's can be varied between around 0,1Hz and 10Hz (or its cyclic period between 10 seconds and 100milliseconds). The speed of LFO1 can also be set alternatively to High Speed mode in the PARAMETER-menu, in this mode the frequency can be varied from around 2Hz to 200Hz.

The waveform of LFO1 and LFO2 can be set to TRI (triangle), SAW (sawtooth), SQU (square) and SIN (sinus) by pressing the WAV1 and WAV2 buttons.

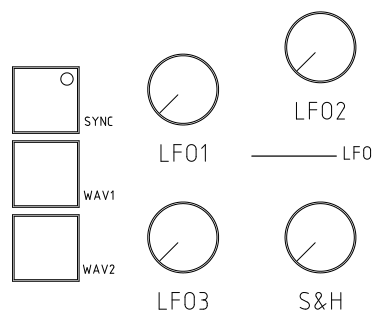

- LFO1 is hardwired to the oscillator section to perform pulse width modulation (PWM) and other modulations of the MOD parameter. LFO1 can be also be set to High Speed mode, allowing its frequency to go up to a few hundreds of Hz. LFO1 makes a "separate" LFO for each active note, each played note starts its own LFO1.

```
PARAMETER
LFO1 Speed : HI
```

- LFO2 is hardwired to the filter section to modulate the cutoff frequency and the formant morph. LFO2 is a global lfo, identical to all playing notes. LFO2 can

be synced to an external MIDI clock, by hitting the SYNC button in the LFO section.

```

A00 Init
LFO2 SYNC : ON

```

- LFO3 is a global triangle LFO of which the amplitude depends on the setting of the MODWHEEL, found next to the pitch bend wheel on most synth keyboards. If the modwheel is down the amplitude of LFO3 is zero, with the modwheel fully up LFO3's amplitude is identical to the other LFO's. If LFO3 seems to have no effect, turn up the modwheel.

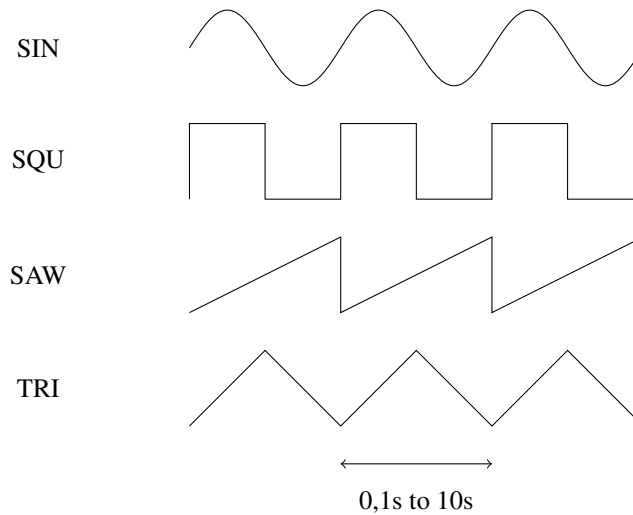

```

A00 Init
LFO2 WAVE : SAW

```

## 7.2 Sample&Hold

The Sample&Hold modulation signal is a signal that jumps to random values in a pace set by the S&H speed control in the LFO-section. At lower speeds the separate steps are clearly audible, while at high speeds the effect is quite identical to modulation using a real noise source.

The sample&hold modulator is not hardwired to any parameter, but upon patch initialisation it is selected as the source for pitch modulation (see also §7.5). When no oscillator is selected (OSC1, 2 & 3 button leds are off), turning the LFO control in the OSC section activates pitch modulation by a menu selectable source that is S&H after patch initialisation.

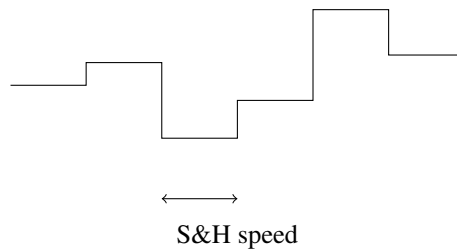

There is also a LS&H or lowpass sample&hold variant of this modulator that can be chosen as modulation source. The LS&H makes a somewhat more fluent "glide" from one value to another, which can sometimes give better effects in cases where too sudden changes in a modulator can give unwanted effects.

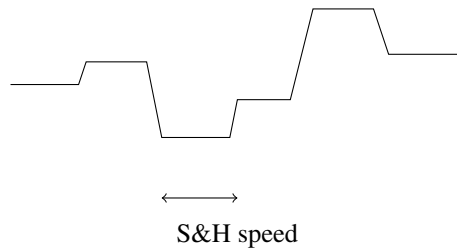

### 7.3 Envelopes

The envelopes of the Modor NF-1 are more sophisticated than the classic ADSR-envelopes found on many synthesizers. The envelopes are 3 stage + release envelopes, and therefore contain more controls than found on typical ADSR-envelopes.

There are four envelopes on the Modor NF-1. You select which envelopes you want to edit using the ENV1 ... ENV4-buttons on the left side, much like the OSC-selection buttons in the OSC section. The envelope which' led is lit is being edited when you turn one of the controls of the ENV-section.

The envelopes can be set to looping mode by double-clicking their selection button.

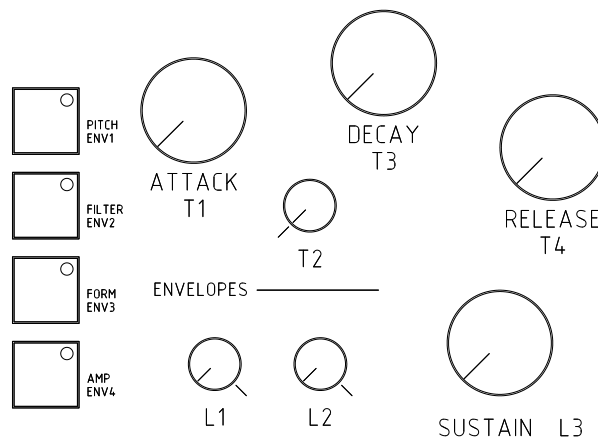

**Non-looping envelope** The envelope output level of a non-looping envelope runs from zero over level L1 and level L2 to level L3 where it is held as long as the note is held on the keyboard. After the release of the key it drops again to zero. The times to move from one level to another are set by the time parameters T1 ... T4. T1 for 0→L1, T2 for L1→L2 and T3 for L2→L3. T4 is the release speed at which an envelope shrinks back to zero after the key has been released.

```
PARAMETER
ENV Loop :xxxxx
```

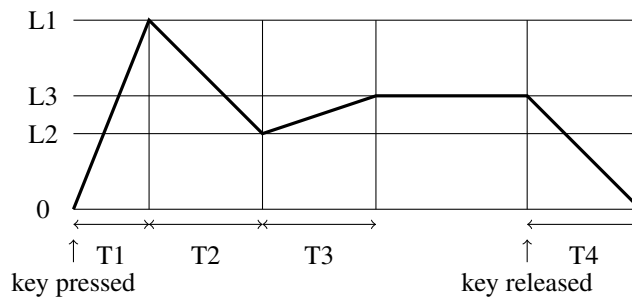

**Looping Envelope** By double-clicking the ENV1-ENV4 button, the corresponding envelope goes into looping mode. Looping means that, instead of staying at the SUSTAIN-level (L3) for as long as the note keeps being pressed, the envelope goes immediately into release and drops back to zero, to restart from the beginning after arriving there. This way you can use your ENV's as a kind of user shapeable LFO's.

If you set ENV4 to looping mode your notes don't stop playing anymore, but keep 'droning' until you stop the looping mode. This can be quite disturbing the first time, but it can be used to create special soundscapes!

```
PARAMETER
ENV Loop :1234
```

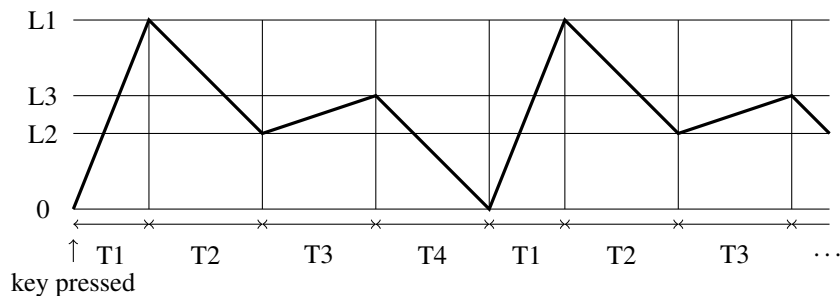

When you double-click one of the ENV1-ENV4 selection buttons, an 'x' on the

screen indicates that the envelope is not looping, while a number (1, 2, 3 or 4) indicates that that envelope is in looping mode. It's also possible to get into the PARAMETER-menu to alter the ENV Loop-setting over there.

The 4 envelopes available on the Modor NF-1 (ENV1, ENV2, ENV3 and ENV4) are hardware-connected to the following parameters:

ENV1	⇒	MOD OSC1	When OSC1 is selected (OSC1 selection switch is lit) the ENV control in the oscillator section sets the modulation amount of OSC1's MOD parameter by ENV1
ENV1	⇒	PITCH	When all oscillators are deselected (no leds in the OSC selection switches) the ENV control in the oscillator section sets the pitch envelope amount
ENV2	⇒	MOD OSC2	When OSC2 is selected (OSC2 selection switch is lit) the ENV control in the oscillator section sets the modulation amount of OSC2's MOD parameter by ENV2
ENV2	⇒	FILTER	ENV2 also alters the filter frequency by an amount set using the filter envelope control. (FILT ENV)
ENV3	⇒	MOD OSC3	When OSC3 is selected (OSC3 selection switch is lit) the ENV control in the oscillator section sets the modulation amount of OSC3's MOD parameter by ENV3
ENV3	⇒	FORMANT	ENV3 also alters the formant morph parameter by an amount set using the formant envelope control. (FORM ENV)
ENV4	⇒	AMP	ENV4 determines the sound volume (AMP ENV)

The complex 7-parameter envelopes can be turned into a classic ADSR-envelope by setting L1 and L2 at maximum and T2 at zero. When you make those settings, the other controls are the Attack, Decay, Sustain and Release controls. These settings to make the 7-parameter envelope into an ADSR envelope are indicated with a small black line on the frontpanel of the Modor NF-1 (some of the earlier models don't have this indication) to easily remind you of how to set L1-L2-T2 to get a classic ADSR envelope.

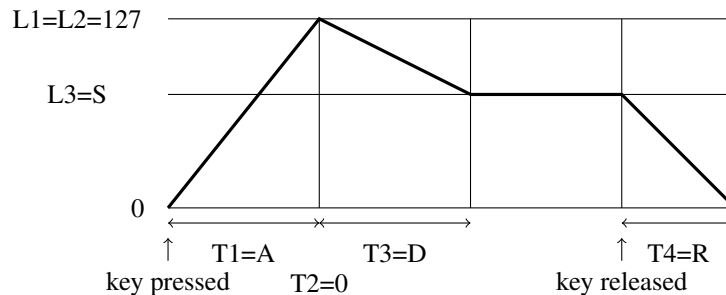

- T1 = Attack
- L1 is set at maximum (127)
- T2 is set at minimum (0)
- L2 is set at maximum (127)
- T3 = Decay
- L3 = Sustain
- T4 = Release

## 7.4 Modulation Matrix

The Modor NF-1 has a "modulation matrix" of 7 freely assignable modulation lines (called "wires") that can route some modulation source signals to a large number of destination parameters, opening a near endless number of modulation possibilities.

To set up a modulation "wire" push the source button (SRC/YES) a few times to select WIRE 1, 2, ... 7, and turn the SELECT encoder to select a source signal. Next, push the destination button (DEST/NO), turn the SELECT encoder to select a destination parameter and use the VALUE control to set a positive or negative modulation amount.

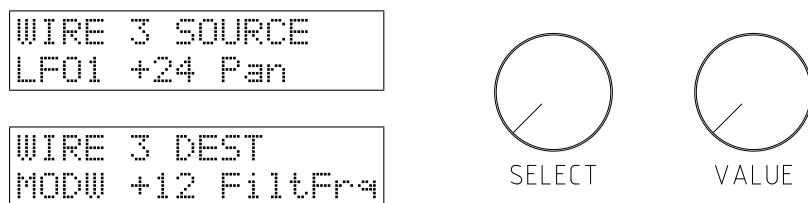

Following source signals can be used:

- LFO1, 2 and 3.
- ENV1, 2, 3 en 4.
- VELO: Velocity. Gives a signal according to how hard a note's key is hit. You need a velocity sensitive keyboard for this.
- KEYB: A modulation signal dependent on a notes pitch. The higher the note, the higher the modulation signal.
- MODW: The modulation wheel. This gives a high signal when the modulation wheel is up, and a low signal when the wheel is down. Also MIDI control change #001 sets this modulator.
- PBND: The pitchbend signal gives a positive or negative signal depending on the pitchbenders position relative to the center.
- PEDL: the position of the volume pedal, that can be attached to the PEDAL-connector at the backside. Also MIDI control change #004 sets this modulator.
- RNDM: a random value chosen at the start of a new note.
- S&H: A modulation signal that changes to a new value on a regular interval, set by the S&H speed control.
- LS&H: LS&H is a lowpass filtered version of the S&H signal, it glides from one level to another instead of suddenly jumping.



- AFTR: Aftertouch is a signal dependent on how hard a note key is pushed after the initial attack. You need an aftertouch sensitive keyboard for this. The NF-1 reacts to both channel and polyphonic aftertouch.
- BRTH: The breath controller or MIDI control change #002. This modulator can only be fed externally to the NF-1 through MIDI.
- CC3 : MIDI control change #003. This modulator can only be fed externally to the NF-1 through MIDI.

These modulation sources can be coupled to a long list of modulatable destination parameters:

- Pitch, Modification (MOD) and Level of each of the 3 oscillators OSC1,2,3
- Pitch
- Level
- Pan
- Filter frequency and resonance
- Formant filter morph and formant mix
- Drive
- Ring modulator volume
- All Envelope parameters of every envelope
- LFO1 speed
- FM carrier and modulator harmonics
- The modulation amounts of other modulation wires...

And also:

- LFO2, LFO3 and S&H speed
- Chorus/Flanger Mix, Speed, Delay and Depth controls
- Delay Mix, Time, Feedback and Filter controls

The first group are the "local" parameters. Every note in the polyphonic mix can have a different value for this parameter. The second group are so-called "global" parameters, they are identical for all the notes in the polyphony. The global group contains all of the effect parameters and the lfo speed settings for all lfo's except LFO1.

The effect sections work on the mix of all polyphonic notes together. Thus, for example if an ENV is chosen as modulation source for an effect parameter, which polyphonic note's envelope is to be taken? If two notes are played together, they will probably have two envelopes playing at different points. In these cases, it's always the most recently played note that delivers the modulation signal. The same goes for the LFO2, LFO3 and S&H speeds as they are global modulation sources, their phase and speed is always identical for all notes in the polyphony. LFO1 on the contrary can show a different phase in different simultaneously played notes. Even the LFO1 speed can be different for every note.

## 7.5 Pitch Modulation

The front panel of the Modor NF-1 doesn't seem to show any pitch modulation controls. But they're not far away. If all three oscillator selection buttons (OSC1, OSC2 and OSC3) are deselected, the LFO and ENV controls in the oscillator section double up as pitch modulation controls. Other pitch modulation lines are preset in the free modulation lines after patch initialisation.

**Pitch LFO** When OSC1, OSC2 and OSC3 buttons are disabled, you can turn the LFO-control in the OSC section to get an amount of LFO or S&H pitch modulation. After patch initialisation, the pitch LFO source is set to "S&H". This can be adapted in the parameter menu (see §9) or with the WAVEFORM-button while OSC1, OSC2 and OSC3 buttons are disabled. You can select LFO1, LFO2, S&H and LS&H as pitch LFO source.

```

A00 Init
Pitch LFO : +27

```

**Pitch Envelope** Also, there is no dedicated pitch envelope control on the front panel of the Modor NF-1, but with OSC1, OSC2 and OSC3 buttons disabled you can use the ENV-control of the OSC section to set an amount of pitch modulation by ENV1.

```

A00 Init
Pitch ENV : +12

```

**Portamento** Using the GLIDE-control on the frontpanel, a certain amount of 'glide' or 'portamento' is activated. The note pitches seem to glide to one another, with a speed controlled by the GLIDE-control.

**Pitch Bend** The pitch bend amount can be found in the PARAMETER menu. Upon patch initialisation, this amount is set at +24, to allow 1 octave up/down pitch bends. (When MPE-mode is active, the default value is +48 for correct pitch tracking).

```

PARAMETER
Pitchbend : +24

```

But of course the pitchbend is also available as a modulation source in the modulation matrix. So you can use the pitchbend wheel for other modulations too.

**Modwheel vibrato** LFO3 is used to create the very typical vibrato effect using the modwheel, as found on almost any synthesizer. After patch initialisation, LFO3 is routed a certain amount to pitch. When you turn up the modwheel of your master keyboard you'll here the pitch going up and down. The LFO3-control sets the speed, the modwheel sets the intensity of this effect (actually, it sets the amplitude of LFO3). The parameter to set this vibrato intensity can be found in the PARAMETER menu.

```

PARAMETER
ModwVibrato: +32

```

But of course, the modwheel is also available as a modulation source in the modulation matrix. So you can use the modwheel for other modulations too.

## 7.6 Amplitude Modulation

Apart from the pitch modulations, there are also a number of popular basic amplitude modulations preset in the free modulation lines (§7.4).

**Tremolo** After patch initialisation, the third modulation wire is preset as a tremolo effect. Push the Src/Yes or Dst/No button 3 times and set the tremolo amount with the VALUE-control.

```
WIRE 3 SOURCE
LF01 +29 Level
```

**Volume pedal** The fourth modulation wire is preset at initialisation to use a foot pedal to control the volume. The PEDL modulation source is controlled by a pedal connected to the pedal connector on the backside, or using Midi control change CTRL#007 from your sequencer or master keyboard.

```
WIRE 4 SOURCE
PEDL -32 Level
```

**Velocity** The fifth modulation wire is preset to achieve a velocity effect. The harder you play the notes on the keyboard, the higher the volume if you set a positive amount on this modulation wire. It might be necessary to lower the Volume parameter in the PARAMETER menu a bit to have more effect. Your master MIDI keyboard needs to be velocity sensitive for this.

```
WIRE 5 SOURCE
VELO +32 Volume
```

It is also very rewarding to route a certain amount of velocity to other mod destinations. This really livens up the sound of your synthesizer when playing on a keyboard, making every note sound a bit different and more expressive.

## 7.7 Other popular modulations

**Velocity sensitive Filter ENV amount** Often found on many synthesizers: a velocity sensitive filter envelope. The first modulation wire is preset by default for this option by linking Velocity to the Filter Envelope Amount (FiEnvAm). A positive setting makes the filter envelope more pronounced when playing harder.

```
WIRE 1 SOURCE
VELO +05 FiEnvAm
```

**Stereo panning** It can be interesting to modulate the stereo position of a sound. For example by the KEYB-modulator to put the higher notes a bit more to the right, and the lower a bit to the left. Or route a small amount of the RNDM-modulator to the Pan-parameter, to give every note a bit different position in the stereo image . . .

```
WIRE 6 SOURCE
KEYB +05 Pan
```

**ENV decay curve** Envelope self-modulation. A popular trick among professionals. You can modulate the decay (or attack) of an envelope by the envelope itself. This alters the decay (attack) curve, which often proves to be interesting, for example in fast FM envelopes. Route the envelope (source) to the decayparameter of that same envelope and set an amount of modulation. . .

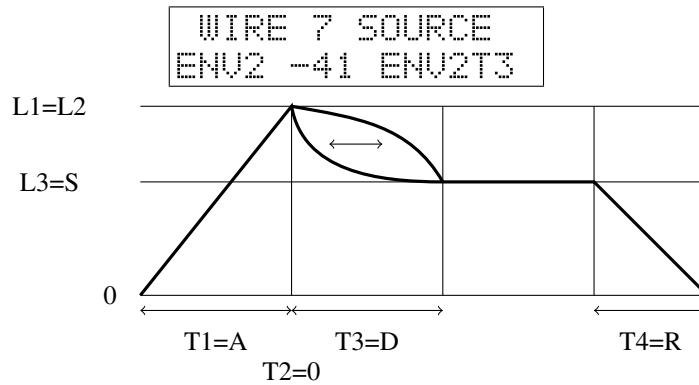

**And so on . . .** And of course, a lot more modulation wires can be set up! How about an envelope that alters the oscillator mix? The aftertouch (which can be channel or polyphonic aftertouch) opening and closing your filter? A stereophonic pan position varied by a random Sample and Hold? A pedal to set your envelopes attack speed? A random LFO speed? A velocity sensitive formant filter? Delay echos becoming stronger and weaker at the pace of an LFO? . . . Literaly hundreds of combinations, only limited by your imagination!

## Tempo synchronisation

The Modor NF-1 has two sync buttons at it's frontpanel: one in the LFO section and one in the Delay section. They can be used to synchronise the delay's and LFO2's cycle time to the tempo of the music you're playing. But how exactly does this work?



After pressing the SYNC button (the led inside the sync button is burning), you can choose the synchronised pace of the LFO/delay. When turning the LFO2 speed control or the delay section's TIME control you see a musical symbol showing the actual synchronisation pace.

**Internal or external sync** Synchronisation can be done to an internal clock or to the Midi Clock signals that can be sent to the NF-1 by an external sequencer, computer, DAW... This can be set separately for the delay effect and LFO2. So it's perfectly possible to synchronise the delay effect internally, and the LFO externally. Switching between internal/external syncing can be done by double-clicking the SYNC button.

When external sync is set, and a midi clock is received the led inside the Sync button is blinking at the chosen pace. This can be used as an indication to check if the NF-1 receives an external midi clock.

**Setting the internal tempo** The tempo of the internal clock can be set in two different ways: either in the SYSTEM SETTINGS menu, or by turning the TIME (delay) or LFO2 speed control while keeping the SYNC-button pressed down.

Remark: There's only one single internal tempo for both the LFO and delay synchronisation.

**Synchronising the delay effect** The delay effect can be synced from 16th notes to half notes:



The delay length however goes up to 0.75sec at maximum. So if you set the delay synchronisation to a long note when playing in a slow tempo, the delay length may get limited to this maximum.

You'll probably synchronise the delay effect section quite often to the *internal* clock, as slight imperfections in the external clock may cause the delay time to jump between different values. This results in an unstable pitch of echos. Double-click the DELAY section's SYNC-button to switch between internal and external delay syncing.

**Synchronising LFO2** LFO2 can be synchronised from 16th notes to double whole notes:



You'll probably synchronise LFO2 quite often to the *external* clock, as a slight mismatch between the internal and the external clock will get slight timing errors to start building up. This results in an LFO going out of pace, sometimes even quite quick. Synchronisation to the external clock keeps the LFO exactly in pace. Double-click the LFO section's SYNC-button to switch between internal and external LFO syncing.

## Menu Reference

The menu of the Modor NF-1 exists out of 9 menu items. When the menu button is hit you enter the menu, and the first menu item appears on the upper display line, while a black dot moves from right to left over the screen. By pressing again before it reaches the left side, the next menu item is selected. If you stop hitting "Menu", the black dot reaches the left side. You now entered this submenu. Following menus can be entered:

1. **LOAD:** Load a patch from internal memory
2. **SAVE:** Save a patch in the internal memory
3. **NAME:** Give your patch a name
4. **PATCH INIT:** Initialise this patch
5. **PARAMETER:** To adapt a few sound parameters that have no knob on the front panel
6. **SYSTEM SETTINGS:** To set some global system parameters
7. **TONESCALE:** Change the tuning of the actual patch with 1/4 notes up or down
8. **FRMFRQ:** Set formant frequencies of this patch's formant filter
9. **MIDI DUMP:** Dump a single patch, a patch bank or the complete patch memory using Midi Sysex messages

Next, after entering a certain menu, data can be selected and altered using the SELECT-encoder and VALUE-knob. Sometimes you need to approve or cancel your choice by using SRC/YES or DEST/NO. While in the menu, on any moment you can press DEST/NO to cancel and leave the menu.

### 9.1 Load

After entering the Load-menu, you can select a patch in the synth's memory using the SELECT- and/or VALUE-control. The SELECT encoder selects a patch in the active bank, with VALUE and/or the MENU-button you choose the active patchbank. The selected patch is temporarily loaded into the memory, and can be played on the keyboard. This way you can browse through the available patches in memory, while the original patch you were working on does not yet get lost. Next:

- Pressing the NO/DEST-button cancels the load-operation, exits the menu and restores the active patch you were working with before entering the menu.

- Pressing the YES/SRC-button finishes the load operation and exits the menu. The active patch gets replaced by the selected patch from memory.

```
LOAD?           Y/N
A25 NoisyChrd4
```

## 9.2 Save

After entering the Save-menu, you can use the SELECT- and VALUE-controls and MENU-button to select a spot in the synth's memory to store your patch, the same way as in the load menu. The SELECT encoder selects a patch in the active bank, with VALUE and/or the MENU-button you choose the active patchbank. The patch you select is temporarily loaded in the synth's memory such that you can listen to the patch that's going to be overwritten, to make sure you don't overwrite the wrong patch.

- Pressing the NO/DEST-button cancels the save operation, and exits the menu.
- Pressing the YES/SRC-button writes the actual patch into the synth's memory on the selected spot and exits the menu. This memory spot is now permanently overwritten.

```
SAVE?           Y/N
C12 Hoover
```

## 9.3 Name

In this menu, you can change the name of the actual patch with the Select and Value buttons. Use the VALUE-control to select a character position. With the SELECT-encoder you choose a character.

- Pressing the NO/DEST-button cancels the naming operation and exits the menu.
- Pressing the YES/SRC-button confirms the new patch name and exits the menu.
- Pressing the MENU-button switches between latin characters and numbers, and cyrillic characters.

```
NAME?           Y/N
G05 FM Bass
```

## 9.4 Init Patch

In the PATCH INIT-menu you can reset the active patch to start building up a new patch completely from scratch in two different ways, or you can reload the autosave-data:



- Initialise: restart with a clean sawtooth on one oscillator without filtering, modulations or effects to build up a new instrument from scratch.
- Frontpanel: set all the continuous parameters (those that have a turning knob) according to their actual frontpanel control positions. For the envelopes and oscillators they are only set for the active oscs and envs, those with a burning led in their selection button. The non-continuous parameters remain unchanged (osc/lfo waveforms, filter config, etc...).
- Autosave: Reload the autosave-data. When you don't touch any of the controls during 1 minute, the actual patch is autosaved. After accidentally overwriting, power loss, ... you can reload this autosave data.

Quickly hit the MENU button four times to select the INITIALISE-menu and wait one second to enter it (the black dot reaches the left side of the screen).

- Turning the SELECT-encoder selects between 'Initialise', 'Frontpanel' and 'Autosave'.
- Pressing the YES/SRC-button confirms the initialisation and exits the menu.
- Pressing the NO/DEST-button cancels and exits the menu.

```
PATCH INIT
Initialise? Y/N
```

## 9.5 Parameter

Although there are many controls on the Modor NF-1 frontpanel, a few parameters can not be changed with a dedicated control. They have to be changed in the PARAMETER-menu. Select the parameter to edit using the SELECT encoder, and change it using VALUE. Leave the menu using the MENU or NO/DEST switch.

```
PARAMETER
Pan           : +00
```

- Pan: panoramic position of the patch in the left/right stereo image [-64 - +63].
- Level: Patch volume, which is by default set at 100 [0 - 127].
- PitchBend: The amount of pitchbend applied when turning the pitchbendwheel [-64 - +63]
- ModwVibrato: The amount of pitchbend vibrato by LFO3 when turning the modwheel [-64 - +63]
- LFO1 Speed: choose between HI and LO speed setting for LFO1 [LO,HI]
- PitchLFOSrc: choose the source for the LFO pitch modulation [LS&H, S&H, LFO2, LFO1]
- Mono/Poly: switch between polyphonic, monophonic and mono-legato playing modes [Poly, Mono, Leg], see §1.6
- Env Loop: set the envelope looping for envelopes ENV1-ENV4

## 9.6 System Settings

In this menu a few global settings can be edited. These parameters act globally and do not depend on the selected patch. Select the parameter to edit using the SELECT encoder, and change it using VALUE. Leave the menu using the MENU or NO/DEST switch.

```
SYSTEM SETTINGS
MIDI Channel:11
```

- **Midi Channel:** The MIDI channel upon which the midi data are received and transmitted [1,16]
- **Master Tune:** Here you can change the general tuning of the synthesizer, to play together with other instruments which might be tuned a bit higher or lower [-64,+63]. At a master tune of zero, the note A5 (1a in the fifth octave) has a frequency of 440Hz.
- **ProgChangeRx:** choose if the Modor NF-1 responds to incoming MIDI Program Change messages or not [ON,OFF]
- **CtrlChangeRx:** choose if the Modor NF-1 responds to incoming MIDI Control Change messages or not [ON,OFF]
- **SysexRx:** choose if the Modor NF-1 receives or ignores incoming MIDI sysex messages [ON,OFF]
- **CtrlChangeTx:** choose if the Modor NF-1 sends MIDI Control Change messages when turning a control on the front panel [ON,OFF]
- **ShowCtrlInpt:** choose whether incoming MIDI controller messages are displayed on screen or not [ON,OFF]
- **ShowAfrInpt:** choose whether incoming MIDI aftertouch messages are displayed on screen or not [ON,OFF]
- **ShowBendInpt:** choose whether incoming MIDI pitch bend messages are displayed on screen or not [ON,OFF]
- **Safety Mode:** switches Safety Mode on or off. When this Safety Mode is activated, the sound parameters do not change when turning a frontpanel knob, until you are passing it's actual value, see §1.7 [ON,OFF]. Put this OFF if you don't know what this is.
- **ENVIdleCtrl:** switches the MIDI controller function for the ENV section off [ON, OFF], see below. Put this OFF if you don't know what this is.
- **Load Preview:** With Load Preview ON, you immediately hear the selected patch when scrolling in the LOAD-menu. With Load Preview OFF, you need to confirm (Y/N) before you're able to hear the loaded patch. [ON, OFF]
- **MPEmode:** Select if the NF-1 responds to Midi Multidimensional Polyphonic Expression (MPE). See below [up to 15 channels]
- **Delay Sync:** Select the internal clock or external midi clock messages as the source for delay synchronisation. This can also be selected by double-clicking the delay SYNC-button. [INT, EXT]
- **LFO Sync:** Select the internal clock or external midi clock messages as the source for LFO2 synchronisation. This can also be selected by double-clicking the SYNC-button in the LFO section. [INT, EXT]

- **Internal BPM:** Select the internal clock speed. You can also set this by turning TIME while keeping the delay SYNC-button pressed, or by turning LFO2 speed while keeping the lfo SYNC-button pressed [0 - 254]
- **OS Version:** check the version number of the currently installed operating system.

**Safety Mode** See §1.7.

**Envelope Idle MIDI controller** You can use the Modor NF-1 as a small MIDI controller with the ENVIDleCtrl option. When the ENVIDleCtrl option is ON, the 7 controls of the ENV section can be used to send out MIDI control changes. This might be useful for example to control another module in a MIDI setup that has no, or only very few controls.

When all envelopes are disabled (no leds in the ENV1-ENV4 buttons are lit, the ENV section is 'idle'), the Modor NF-1 sends out MIDI Control Change messages when turning one of the 7 envelope controls (L1-L3, T1-T4).

```
SYSTEM SETTINGS
EnvIdleCtrl :ON
```

```
SYSTEM SETTINGS
T3 Idle CC# :079
```

When turning one of the 7 controls of the ENV section while you are on this option in the SYSTEM SETTINGS menu, you choose which midi controller number is sent for each of the 7 controls. Next, when you quit the menu and turn one of these controls (with the envelopes still disabled) the NF-1 sends out midi controller data.

```
A00 Init
CC 079 OUT : 092
```

**MIDI Multidimensional Polyphonic Expression (MPE)** MPE is a MIDI protocol that uses a large number of midi channels for a single instrument where every active note gets it's own dedicated MIDI channel. This makes it possible to vary certain parameters for every note separately.

For example, an MPE compatible keyboard can send pitch bends for glissando's or vibrato's on one note, while another note playing simultaneously stays on pitch. Or pressure variations per finger can open or close the filter cutoff per note. Or ... Two examples of MPE keyboards or the Linnstrument and the Roli Seaboard.

- MPE uses a Master Channel for reception of global Midi messages. Controllers that come in on the master channel act on all notes in play, like regular controllers in normal MIDI. On the NF-1 this master channel is the MIDI Channel that can be set in the SYSTEM SETTINGS menu.

```
SYSTEM SETTINGS
MIDI Channel:01
```

```
SYSTEM SETTINGS
MPEnode:01,02-13
```

- On top of this Master Channel, there's a number of "note channels" that accept note on/off messages and per-note expressions by Pitchbend, Aftertouch and Controller CC#74 (SLIDE).

- All other Midi Channels, next to the master channel and note channels are ignored by the NF-1. So they can still be used for other instruments connected via MIDI THRU.

## 9.7 Formant Frequencies

In this menu the precise setting of the formants in the formant filter can be altered in detail. Note that you also can choose from a number of preset formant frequency sets using the VOWEL-button in the Formant filter section, altering the formants in this menu can be considered as "advanced patch editing".

Use the SELECT encoder to select one of the three vowels 1-2-3. The VALUE knobs sets the relative volume of this vowel. The knobs ATTACK/T1, DECAY/T3, SUSTAIN/L3 and RELEASE/T4 are used to set the formant frequencies of the selected vowel. Thus, these knobs temporarily get another function when the FRMFRQ menu is active. Leave the menu using the MENU or NO/DEST switch.

```
FRMFRQ1  64 770
          1272 2048 3325
```

While changing the formant frequencies you may notice that the sound sometimes suddenly seems to get blocked and reduced to a much weaker volume. This is a safety compressor which gets activated whenever the formant filter becomes unstable. Not every combination of formant frequencies results into a stable filter, sometimes the filter results just runaway and the filter would suddenly produce very loud heavily distorted noise signals. These might damage your speakers, or worse, your ears. Therefore this safety compressor has been installed to intervene immediately when the formant filter gets unstable.

The formant frequencies are saved as part of a patch in the Modor NF-1. A patch using a user-adapted formant frequencies gets saved with it's special formant frequencies, without affecting other patches. The normal formant frequencies are restored upon patch initialisation, or after loading a patch with the standard formant frequencies. The special formant settings gets recalled whenever the patch is loaded again.

## 9.8 Tonescale

At initial settings, the Modor NF-1 has a standard tuning existing of 12 equal subdivisions (half tones) in an octave. Most modern-day western musical instruments use this tonescale of 12 equally spaced pitches in an octave, including almost all synthesizers. This tonescale is called the "equal-tempered tonescale". However, many historical and ethnic instruments are capable of playing more than only this basic set of 12 halve-tones, thereby evoking strange and exotic melodies and musical characters. For example, modern oriental music still heavily relies on the use of other tonescales highly different from the equal-tempered scale.

Without trying to be exhaustive in the complex domain of ethnic tonescales and microtonality (there are literally hundreds or thousands of tonescale possibilities in ethnic and microtonal music), the Modor NF-1 offers a possibility to vary and experiment with the tonescale. You are able to add or subtract a quarter tone to the pitch of each one of the 12 half tones in an octave.

The diagram illustrates the SYSEX DUMP menu with three examples of musical staves and their corresponding tuning adjustments:

- Staff 1:** Shows a scale with all notes sharp (C#D#EF#G#A#B) and a plus sign (+) for each note, indicating they are pitched up by a quarter tone.
- Staff 2:** Shows a scale with all notes natural (CDEFGAB) and a minus sign (-) for each note, indicating they are pitched down by a quarter tone.
- Staff 3:** Shows a scale with all notes sharp (C#D#EF#G#A#B) and a plus sign (+) for each note, indicating they are pitched up by a quarter tone.

In the tonescale menu, you see the 12 tones of an octave in the upper line of the display, and a set of zeros, plus- and minus-signs on the second line. A zero means that this tone stays at the original pitch, a set of 12 zeros means that the original equal-tempered tonescale remains unchanged. A plus-signs means that the corresponding tone in the upper line is pitched up by a quarter tone, a minus-sign means it is pitched down by a quarter tone. Use the SELECT encoder to select one of the 12 notes, and change it's tuning with the VALUE control.

The tonescale is saved as part of a patch in the Modor NF-1. A patch that is used in a song using a deviating tonescale can be saved with it's special tonescale, without affecting other patches. The normal tonescale is restored upon patch initialisation, or after loading a patch with the normal tonescale. The special tonescale gets recalled whenever the patch is loaded again.

## 9.9 Sysex Dump

A Sysex or "System Exclusive" message is commonly used to send the contents of a synth's memory to an external device for backup or external editing, a so-called "sysex dump". The contents of the memory are put into a long string of parameter numbers and send out over midi, where an external computer or sequencer can capture and store them. On a later moment, the sysex data can be sent back towards the synth to restore it's memory to the situation at the moment of the sysex dump. A way to make "backups" of the synth's memory, or to exchange patches between two Modor NF-1s or between an NF-1 and an NF-1m.

Another use of sysex-messages is to perform firmware updates of a midi device's operating system. Instructions on how to install firmware (OS) updates on the NF-1 are distributed together with the OS-updates.

In the SYSEX DUMP menu you can choose between "Patch dump", "Memory dump", "Bank Dump" and "Bank Receive" turning the SELECT-control. All these sysexes are fully compatible between the NF-1 and the NF-1m *if they have at least OS010 (NF-1) or OS003 (NF-1m).*

**Patch dump** With Patch Dump you send out a sysex message containing the actual set of parameters of the active patch. Press the MENU-button once, and confirm with SRC/YES (or cancel with DEST/NO).

```
SYSEX DUMP
Patch Dump
```

**Memory dump** A Memory Dump creates a very long sysex message containing all of the patches in memory, from memory positions A00 upto N31. This way you can create a backup of the complete memory of the Modor NF-1. Select the SYSEX DUMP menu by pressing MENU 9x, turn the SELECT-control to select Memory Dump, press MENU again, and hit SRC/YES to confirm (or cancel with DEST/NO).

```
SYSEX DUMP? Y/N
Memory Dump
```

**Bank Dump** A bank dump contains the 32 patches of 1 bank [A-N], to make it possible to dump larger groups of patches. Select the SYSEX DUMP menu with the MENU button (9x), and use the SELECT-encoder to select the Bank Dump option. Next, push MENU again to get into the following screen:

```
SYSEX DUMP? Y/N
Bank Dump      A
```

Now use the SELECT encoder to select which bank to dump [A-N], and press SRC/YES to start the sysex dump (or DEST/NO to cancel).

**Bank Receive** A sysex bank dump is only received when your NF-1 is in the SYSEX DUMP-menu, on the Bank Receive option. This is necessary to select at what location [A-N] the incoming bank dump is to be saved. An incoming Sysex Bank Dump is ignored when the NF-1 is not in this menu mode. If the reception of bank dumps doesn't seem to work, it's probably because you need to get into this menu option.

```
SYSEX RECEIVE
Bank Receive  A
```

Select the SYSEX DUMP menu using the MENU-button (9x), and next use the SELECT-encoder to select Bank Receive. Now press the Menu Button again to enter sysex bank receive and use the SELECT-encoder to select a bank [A-N] where to save the received bankdump.

Note that if the Modor NF-1 receives a Patch dump, this is not yet stored permanently in it's memory. If you want to store the patch you received via a patch dump,

you still have to save it. This is of course different for a bank dump or a full memory dump, where a very large number of patches is sent through midi in a large bulk package. They have to be stored permanently immediatly upon reception of the data.

Note that the Modor NF-1 cannot receive midi bulk memory dumps at any speed. The received data need to be written into flash memory while receiving new data in the mean time. This means that at very high data speeds, some data might get lost.

The sysex messages contain a checksum to detect bad reception, such that you will be informed when something went wrong. Reduce the speed of your sysex program or sequencer if you experience problems with the reception of large sysex dumps.

**9.10 Menu overview**

LOAD	SYSTEM SETTINGS
SAVE	Midi Channel
NAME	Master Tune
PATCH INIT	ProgChangeRx
Initialise	CtrlChangeRx
Frontpanel	SysexRx
Autosave	CtrlChangeTx
PARAMETER	ShowCtrlInpt
Pan	ShowAftrInpt
Level	ShowBendInpt
Pitchbend	Safety Mode
ModwVibrato	ENVIdleCtrl
LFO1 Speed H/L	Load Preview
PitchLFOSrc	MPEnode
Mono/Poly	Delay Sync
ENV Loop	LFO Sync
	Internal BPM
	OS Version
	FRMFRQ
	TONESCALE
	SYSEX DUMP
	Patch Dump
	Memory Dump
	Bank Dump
	Bank Receive



# 10

## MIDI Implementation

### 10.1 Midi implementation chart

MIDI Implementation Chart v. 2.0			
Manufacturer: Modor Music Model: NF-1 Version: 2			
Date: January 2016			
	Transmit	Recognize	Remarks
<b>1. Basic Information</b>			
MIDI channels	[1-16]	[1-16]	
Note numbers	-	[0-127]	
Program change	-	[0-31]	
Bank Select response?	-	[0-13]	[A-N] via cc#32
Modes supported			
Mode 1: Omni-On, Poly	-	No	
Mode 2: Omni-On, Mono	-	No	
Mode 3: Omni-Off, Poly	-	Yes	
Mode 4: Omni-Off, Mono	-	Yes	
Multi Mode	-	No	
Note-On Velocity	-	Yes	
Note-Off Velocity	-	No	
Channel Aftertouch	-	Yes	
Poly (Key) Aftertouch	-	Yes	
Pitch Bend	-	Yes	
Active Sensing	No	No	
System Reset	No	No	
Tune Request	No	No	
Universal System Exclusive:			
Sample Dump Standard	No	No	
Device Inquiry	No	No	
File Dump	No	No	
MIDI Tuning	No	No	
Master Volume	No	No	
Master Balance	No	No	

Notation Information	No	No	
Turn GM1 System On	No	No	
Turn GM2 System On	No	No	
Turn GM System Off	No	No	
DLS-1	No	No	
File Reference	No	No	
Controller Destination	No	No	
Key-based Instrument Ctrl	No	No	
Master Fine/Coarse Tune	No	No	
Other Universal System Exclusive	No	No	
Manufacturer System Exclusive	No	No	
NRPNS	No	No	
RPN 00 (Pitch Bend Sensitivity)	No	No	
RPN 01 (Channel Fine Tune)	No	No	
RPN 02 (Channel Coarse Tune)	No	No	
RPN 03 (Tuning Program Select)	No	No	
RPN 04 (Tuning Bank Select)	No	No	
RPN 05 (Modulation Depth Range)	No	No	
<b>2. MIDI Timing and Synchronization</b>			
MIDI Clock	No	Yes	
Song Position Pointer	No	No	
Song Select	No	No	
Start	No	Yes	
Continue	No	Yes	
Stop	No	Yes	
MIDI Time Code	No	No	
MIDI Machine Control	No	No	
MIDI Show Control	No	No	
<b>3. Extensions Compatibility</b>			
General MIDI compatible?	No	No	
Is GM default power-up mode?	No	No	
DLS compatible?	No	No	
Standard MIDI Files	No	No	
XMF Files	No	No	
SP-MIDI compatible?	No	No	

**10.2 Midi controller list**

Control	Function	Transmitted	Received	Remarks
0		No	No	
1	Modulation wheel	No	Yes	Mod Source MODW <sup>1</sup>
2	Breath Controller	No	Yes	Mod Source BRTH
3	Modulation CC3	No	Yes	Mod Source CC3
4	Expression Pedal	No	Yes	Mod Source PEDL
5	Portamento	Yes	Yes	
6		No	No	
7	Volume	No	Yes	Digital patch volume
8		No	No	
9		No	No	
10	Pan	No	Yes	
11		No	No	
12		No	No	
13	Osc 1 mod LFO1	Yes	Yes	
14	Osc 2 mod LFO1	Yes	Yes	
15	Osc 3 mod LFO1	Yes	Yes	
16	Osc 1 mod ENV2	Yes	Yes	
17	Osc 2 mod ENV3	Yes	Yes	
18	Osc 3 mod ENV4	Yes	Yes	
19	Pitch ENV1	Yes	Yes	
20	Pitch LFO-S&H	Yes	Yes	Source can be selected
21	Comb filter depth	Yes	Yes	
22	Comb filter delay	Yes	Yes	
23	LFO 2 speed	Yes	Yes	
24	Comb filter feedback	Yes	Yes	
25		No	No	
26	Comb filter speed	Yes	Yes	
27	Comb filter mix	Yes	Yes	
28	Delay time	Yes	Yes	
29	Delay filter	Yes	Yes	
30	Delay mix	Yes	Yes	
31	Filter ENV2	Yes	Yes	
32	Bank select	No	Yes	Bank A - N
33		No	No	
34		No	No	
35		No	No	
36		No	No	
37	Filter LFO2	Yes	Yes	
38	Filter KEYB	Yes	Yes	
39	Formant ENV3	Yes	Yes	
40	Formant LFO2	Yes	Yes	
41	Vowel 1 volume	No	Yes	
42	Vowel 2 volume	No	Yes	
43	Vowel 3 volume	No	Yes	

Control	Function	Transmitted	Received	Remarks
44	Wire 1 amount	Yes	Yes	
45	Wire 2 amount	Yes	Yes	
46	Wire 3 amount	Yes	Yes	
47	Wire 4 amount	Yes	Yes	
48	Wire 5 amount	Yes	Yes	
49	Wire 6 amount	Yes	Yes	
50	Wire 7 amount	Yes	Yes	
51	Delay feedback	Yes	Yes	
52	LFO3 speed	Yes	Yes	
53	S&H speed	Yes	Yes	
54		No	No	
55	Osc 1 coarse tuning	Yes	Yes	
56	Osc 2 coarse tuning	Yes	Yes	
57	Osc 3 coarse tuning	Yes	Yes	
58	Osc 1 fine tuning	Yes	Yes	
59	Osc 2 fine tuning	Yes	Yes	
60	Osc 3 fine tuning	Yes	Yes	
61	Osc 1 volume	Yes	Yes	
62	Osc 2 volume	Yes	Yes	
63	Osc 3 volume	Yes	Yes	
64	Sustain pedal	No	Yes	On or Off <sup>2</sup>
65	Osc 1 mod	Yes	Yes	
66	Osc 2 mod	Yes	Yes	
67	Osc 3 mod	Yes	Yes	
68	Filter Type	No	Yes	
69		No	No	
70	Noise level	Yes	Yes	
71	Filter frequency	Yes	Yes	
72	Formant morph	Yes	Yes	
73	Formant mix	Yes	Yes	
74	Filter resonance	Yes	Yes	
75	LFO 1 speed	Yes	Yes	
76	Drive	Yes	Yes	
77	Ring volume	Yes	Yes	
78	ENV 1 T1	Yes	Yes	
79	ENV 2 T1	Yes	Yes	
80	ENV 3 T1	Yes	Yes	
81	ENV 4 T1	Yes	Yes	
82	ENV 1 T2	Yes	Yes	
83	ENV 2 T2	Yes	Yes	
84	ENV 3 T2	Yes	Yes	
85	ENV 4 T2	Yes	Yes	
86	ENV 1 T3	Yes	Yes	
87	ENV 2 T3	Yes	Yes	
88	ENV 3 T3	Yes	Yes	
89	ENV 4 T3	Yes	Yes	
90	ENV 1 T4	Yes	Yes	

Control	Function	Transmitted	Received	Remarks
91	ENV 2 T4	Yes	Yes	
92	ENV 3 T4	Yes	Yes	
93	ENV 4 T4	Yes	Yes	
94	ENV 1 L1	Yes	Yes	
95	ENV 2 L1	Yes	Yes	
96	ENV 3 L1	Yes	Yes	
97	ENV 4 L1	Yes	Yes	
98	ENV 1 L2	Yes	Yes	
99	ENV 2 L2	Yes	Yes	
100	ENV 3 L2	Yes	Yes	
101	ENV 4 L2	Yes	Yes	
102	ENV 1 L3	Yes	Yes	
103	ENV 2 L3	Yes	Yes	
104	ENV 3 L3	Yes	Yes	
105	ENV 4 L3	Yes	Yes	
106	Vowel 1 formant 1	No	Yes	
107	Vowel 1 formant 2	No	Yes	
108	Vowel 1 formant 3	No	Yes	
109	Vowel 1 formant 4	No	Yes	
110	Vowel 2 formant 1	No	Yes	
111	Vowel 2 formant 2	No	Yes	
112	Vowel 2 formant 3	No	Yes	
113	Vowel 2 formant 4	No	Yes	
114	Vowel 3 formant 1	No	Yes	
115	Vowel 3 formant 2	No	Yes	
116	Vowel 3 formant 3	No	Yes	
117	Vowel 3 formant 4	No	Yes	
118		No	No	
119		No	No	
120		No	No	
121		No	No	
122		No	No	
123	All notes off	No	Yes	
124		No	No	
125		No	No	
126		No	No	
127		No	No	

<sup>1</sup>CC01 also engages the modwheel vibrato by LFO3

<sup>2</sup>Sustain pedal [0-63]=Off, [64-127]=On





